



Sanding Products for Retail Stores
Produits de ponçage pour détaillants

Abrasifs JJS inc.

Founded more than 35 years ago, Abrasifs JJS Inc. is an exclusive Canadian importer of coated abrasives made in Switzerland by sia Abrasives.

An experienced team:

- Abrasifs JJS employs over 45 experienced and dedicated employees.

Two facilities in Canada for better service:

- 40 000 sq. feet (3 700 sq. m) warehouse and conversion centre at Lévis Quebec, with over 5 million dollars inventory
- Sales and Marketing organisation in Ontario
- 11 Technical Specialists on the road across Canada
- 24 hour personalized service
- Technical service and training available
- Full line of abrasive products for wood, metals, composites, panels, and body shops

sia Abrasives -

Your key to a perfect surface!

We are a Swiss company (a Bosch company since 2008) with more than 130 years of abrasives knowledge.

sia Abrasives, with its headquarters in Frauenfeld, Switzerland, is one of the world's leading suppliers of innovative abrasives. The company develops, manufactures and markets complete abrasive systems, tailored to specific requirements and applications, for the surface treatment of every type of surface. sia Abrasives employs around 1310 people worldwide and is represented with partners in over 80 countries.

Technology leader

Our choice of premium materials, the latest production and manufacturing equipment and sophisticated production technologies enable us to provide sanding products at the highest level in constant quality.

Innovative solutions

In close collaboration with the leading varnish and paint manufacturers of the furniture and automotive industries, new abrasive standards are set by their own research and development trials. Trendsetting abrasives and genuine product innovations with trendsetting processes result in sanding surface technology.

photo de l'entrepot JJS



JJS warehouse: 5 million dollars inventory
(Lévis, Québec) Inventaire de 5 millions dollars

Abrasifs JJS inc.

Fondé depuis plus de 35 ans déjà, les Abrasifs JJS Inc. est le dépositaire exclusif de produits abrasifs fabriqués en Suisse par sia Abrasives au Canada.

Une équipe expérimentée:

- Abrasifs JJS emploie plus de 45 personnes expérimentées et dédiées.

Deux points de service pour assurer un meilleur service:

- Centre de conversion et entrepôt de 3 700 m. carrés (40 000 pieds carrés)
 - à Lévis, avec un inventaire de plus de 5 millions de dollars
- Présence d'une organisation de ventes et marketing en Ontario
- Une équipe de 11 représentants techniques sur la route répartie à travers le Canada
- Un service personnalisé 24 heures
- Un service technique de haut niveau et possibilité de formation
- Ligne complète de produits abrasifs pour le bois, les métaux, les composites, les panneaux et la carrosserie

sia Abrasives -

votre solution pour une surface parfaite!

Nous sommes une compagnie Suisse (une compagnie Bosch depuis 2008) ayant plus de 130 ans de connaissance dans les abrasifs.

sia Abrasives, situé à Frauenfeld en Suisse, est un des plus important fournisseur mondial de systèmes de ponçage innovateurs. Il développe, fabrique et commercialise des systèmes complets de ponçage pour le traitement de tous les types de pièces et selon des exigences et des applications spécifiques du client. Le groupe sia Abrasives compte quelque 1 310 employés dans le monde entier et se trouve représenté par de nombreux partenaires, dans plus de 80 pays.

Produits suisses de qualité

La sélection soignée de matières premières de haute qualité, les installations de fabrication et de confection les plus modernes et les technologies de production les plus évoluées garantissent des produits abrasifs du plus haut niveau de qualité.

Solutions innovantes

Les abrasifs sia sont perfectionnés en collaboration et selon les exigences des fabricants de peintures et laques pour l'industrie du meuble et de la carrosserie et par une analyse détaillée des matériaux à traiter. Ils représentent ainsi un travail suisse de haute précision et de qualité, avec pour objectif premier - l'obtention de surfaces parfaites.



sia Abrasives: State of the Art Production Facility
(Frauenfeld) Usine de production ultramoderne

TABLE OF CONTENTS

Sandpaper for Hand Sanding / Papier abrasif pour ponçage manuel ...	6 – 28
• Sheets (9" X 11") / Feuilles (230 X 280 mm)	8 – 13
• siasoft Contour Sponges / Éponges siasoft pour contour	14
• Hook & Loop Siafast Sheets / Feuilles auto-agrippantes Siafast	15 – 16
• Sheets & Screens for Drywall / Feuilles & treillis pour placoplâtre	17 – 18
• Siasoft Rolls / Rouleaux Siasoft	19
• Screens for Drywall / Treillis pour placoplâtre	20 – 21
• Economical Sanding Sponges / Éponges de ponçage économiques	22 – 23
• Coloured Sponges / Éponges de couleur	24 – 25
• Rolls / Rouleaux	26 – 27
• Handpads / Tampons	28



TABLE DES MATIÈRES

Sandpaper for Tools / Abratif pour ponçage mécanique..	29 – 48
• Belts / Bandes	31 – 34
• Sheets for Sanders / Feuilles pour ponceuses	35 – 37
• Hook & Loop Siafast Discs / Disques auto-agrippants Siafast	38 – 44
• Self-adhesive Discs / Disques autocollants	45
• Fiber Discs / Disques de fibre	46 – 47
• Flap Discs / Disques à lamelles Siaflap	48
• Grit use / Guide d'utilisation des grains.....	49
• sia-house Display / Présentoir sia-maison	50
• Display / Présentoirs.....	51



CONTACT US

Abrasifs J.J.S Inc. has two points of service. One based in Ontario & another one in Quebec.

Ontario office provides services to customers from Ontario to Western Canada

Quebec office serves customers from Quebec to Eastern Canada

NOUS REJOINDRE

Abrasifs J.J.S Inc. offre deux points de services dont un situé au Québec et l'autre en Ontario.

Le bureau du Québec dessert le Québec et l'est canadien

Celui de l'Ontario reçoit les demandes provenant de l'Ontario et de l'ouest canadien.

JJS Canada Inc.

ONTARIO/WEST CANADA

📍 1251 Gorham Street, Unit 11
Newmarket (ON) | L3Y 8Y6

📞 +1 800 337-1325

📞 +1 905 898-0116

✉️ orderdesk@jjscanada.ca

🌐 jjscanada.ca

JJS Canada Inc.

QUEBEC

📍 900 chemin Olivier,
Levis(QC) | G7A 2N1

📞 +1 800 463-1574

📞 +1 418 836-0557

✉️ commandes@jjscanada.ca

🌐 jjscanada.ca

JJS Canada Inc.

ONTARIO / OUEST DU CANADA

📍 1251 Gorham Street, unité 11,
Newmarket, ON, L3Y 8Y6

📞 +1 800 337-1325

📞 +1 905 898-0116

✉️ orderdesk@jjscanada.ca

🌐 jjscanada.ca

JJS Canada Inc.

QUÉBEC

📍 900 Chemin Olivier,
Lévis, QC, G7A 2N1

📞 +1 800 463-1574

📞 +1 418 836-0557

✉️ commandes@jjscanada.ca

🌐 jjscanada.ca

SALES TEAM – MANAGEMENT – ÉQUIPE DES VENTES

Abrasives JJS technical representative team is composed of **11 abrasive specialists supported by 5 customer service agents.**

This team is supervised by two seasoned managers.

Do not hesitate to contact them!

Notre équipe de représentants techniques est constituée de **11 spécialistes en abrasifs aidés de 5 conseillers au service à la clientèle.**

Cette équipe est supervisée par deux personnes d'expérience.

N'hésitez pas à communiquer avec eux!



Ontario & Western Canada
Ontario & ouest canadien

Paul McIntyre

Directeur régional des ventes
Regional Sales Manager

pmcintyre@jjscanada.ca



Québec & Eastern Canada
Quebec et l'est canadien

Simon Patry

Directeur régional des ventes
Regional Sales Manager

spatry@jjscanada.ca

Business Hours / Heure d'ouvertures

Monday to Thursday

Lundi au jeudi

8:00 – 16:30

Friday

Vendredi:

8:00 – 16:00

(EST / heure de l'est)



Votre source de solutions
Your Solution Partner



Same Day Orders

Abrasifs J.J.S Inc. offers a personalized service to meet your specific needs.

We ship your order the **same day if the order is placed before 10:00 a.m.** (Eastern time). This service is applicable only for stock products. There are no additional charge for this service.

Order Processing

As soon as your order is placed, you will receive an e-mail (or fax) confirmation of your order. Please, read it carefully to avoid any mistakes, including the ship-to address. If errors are found or you wish to modify your order, contact us immediately by phone and we will do our best to accommodate you.

**In the case of a verbal order, the order confirmation is the only document which confirms details of the sale. This document must to be checked by the customer to avoid any mistakes and return charges on the delivered goods.*

Commandes traitées la même journée

sia Abrasifs J.J.S Inc. offre un service personnalisé afin de rencontrer vos besoins spécifiques.

Votre commande est traitée la même journée si celle-ci est déposée avant 10:00 a.m. (heure de l'est). Ce service s'applique pour les produits disponibles et aucune charge additionnelle ne sera imposée pour ce service.

Traitement des commandes

Peu de temps après avoir passé votre commande, vous recevrez un courriel (ou télécopie) de confirmation de commande. Veuillez vous assurer qu'elle ne contient pas d'erreurs, notamment dans l'adresse d'expédition. En cas d'erreur ou si vous souhaitez modifier votre commande, communiquez avec nous immédiatement par téléphone et nous ferons tout en notre pouvoir pour donner suite à votre appel.

**Dans le cas d'une commande verbale, la confirmation de commande est le seul document qui confirme les détails de la vente. Ce document doit donc être revérifié par le client afin d'éviter des frais de retour sur la marchandise livrée.*

NON-STOCK PRODUCTS

We sell the entire line of coated abrasives from which several products are not listed in the present catalogue.

Do not hesitate to contact us to get more information about abrasive products. We will strive to meet your particular needs.

PRODUITS NON-STANDARDS

Nous vendons une gamme complète d'abrasifs dont plusieurs ne sont pas inclus dans le présent catalogue.

N'hésitez pas à communiquer avec nous pour tous besoins en matériels abrasifs. Nous avons probablement ce qu'il vous faut.

TERMS AND CONDITIONS

PRICES: All prices are subject to change without notice. All quotes are firm for 30 days only.

TERMS: Net 30 days. Invoices not paid within 30 days would result in holding other orders. Collection fees will be added to all accounts placed for collection. Items may also be shipped COD.

SALE TAXES: Sale taxes are added when applicable.

RETURNED GOODS: No material can be returned without prior written authorization from Abrasifs J.J.S Inc. All authorized returns must be sent prepaid. Abrasifs J.J.S Inc. will not accept returns with unpaid freight. Claims for loss or damage in transit must be made by writing to Abrasifs J.J.S Inc. within 15 days of invoice date. Authorized returns are subject to 15 % restocking fees. Material found to be defective after examination will be credited to the customer. In addition, prepaid transportation will be refund on defective materials.

LOSS \ DAMAGED MERCHANDISE: Transportation companies assume all liability from the time a shipment is picked up by them until it is delivered to the customer. Abrasifs J.J.S Inc. liability ceases at the time of shipment. Claims for loss or damaged merchandise must be directly made to the delivering carrier.

ADD-ON POLICY: Stock items may be added to an order as long as the original order remains unshipped. Freight and pricing for the additions will be treated the same way as the original order.

CANCELLATION CHARGES: Any orders cancelled as requested by a customer, will be charged to the customer at a price equal to the cost of the material, labour and factory overhead incurred by Abrasifs J.J.S Inc. up to the stage of production reached at the time of cancellation.

CUSTOMER REWORK: There will be a sixty dollars (\$60) per hour charged for the work performed on customer's material. Shipping fees are paid by customers. All work performed will be at the client's risk.

QUANTITY SHIPPED: Quantity shipped may vary for a maximum of ten percent (10%) of the original order.

SIA ABRASIVES PRODUCTS SOLD BY ABRASIVES JJS ARE ONLY DESTINATED TO THE CANADIAN MARKET. RESELL TO THE USA IS FORBIDDEN.

MODALITÉS ET CONDITIONS

LES PRIX: Les prix sont sujets à changement sans préavis. Tous les prix provenant d'une soumission sont assurés durant 30 jours seulement.

CONDITIONS DE PAIEMENT: Net 30 jours. Les commandes impayées après 30 jours peuvent provoquer l'arrêt des commandes subséquentes. Des frais de collections peuvent être ajoutés aux comptes en souffrance. Les items peuvent aussi être envoyés en COD.

TAXES DE VENTE: Les taxes de vente sont en sus le cas échéant.

RETOUR DE MARCHANDISE: Aucune marchandise ne peut être retournée sans l'accord écrit de Abrasifs J.J.S. Inc. Les frais de transport de la marchandise retournée sont à la charge du client. Abrasifs J.J.S. Inc. n'acceptera pas de retour de marchandise si le transport n'est pas payé d'avance. Les réclamations doivent être faites par écrit à Abrasifs J.J.S. Inc. à l'intérieur d'un délai de 15 jours suivant la date de la facture. La marchandise acceptée pour retour fera l'objet d'une facturation de remise en stock de 15 %. Lorsque la marchandise est retournée pour cause de défectuosité et que celle-ci s'avère véritable, elle fera l'objet d'un crédit sans retenu au client. De plus, il y aura remboursement des frais de transport payés d'avance par le client.

MARCHANDISE PERDUE OU ENDOMMAGÉE: Les compagnies de transport assument la responsabilité de la marchandise à partir du moment où elles la reçoivent jusqu'au moment où elles la livrent à destination. La responsabilité de Abrasifs J.J.S. Inc. cesse au moment où la cargaison est transférée au transporteur. Toute réclamation pour perte ou dommage de matériel en cours de route doit être faite auprès dudit transporteur par le consignataire.

PRATIQUES CONCERNANT LES ARTICLES AJOUTÉS: Il est possible d'ajouter des articles conservés en stock à une commande aussi longtemps que la commande originale n'a pas été expédiée. Le prix et les frais pour les additions seront traités de la même manière que pour la commande originale.

ANNULATION: Toute commande annulée à la demande du client sera facturée au client à un prix égal au coût des matières, de la main d'œuvre et des frais généraux de production encourus par Abrasifs J.J.S. Inc. jusqu'au stade de production atteint par la compagnie au moment de l'annulation.

TRAVAUX DE CONDITIONNEMENT SUR DU MATÉRIEL







PROVENANT DES CLIENTS: Les travaux exécutés sur les matériaux provenant des clients feront l'objet d'une facturation de soixante dollars (60 \$) par heure de travail. Les frais de transport sont à la charge du client. Tous ces travaux sont effectués aux risques du client.

QUANTITÉ LIVRÉE: Les quantités livrées peuvent varier d'un maximum de dix pourcent (10%) de la commande originale.

LES PRODUITS SIA ABRASIVES VENDUS PAR ABRASIFS JJS SONT UNIQUEMENT DESTINÉS AU MARCHÉ CANADIEN. IL EST INTERDIT DE LES REVENDRE AUX USA.

Product information

Charte des produits

Woods Bois	#1902 	40 to / à 240 Aluminum Oxide Stripping Bare wood Paint Varnish Lacquer	Oxyde d'aluminium Décapage Bois nu Peinture Vernis Laque
All Purpose Tout usage	#1960 	40 to / à 600 Aluminum Oxide High performance Stripping Bare wood Metal, plastics Paint Varnish Lacquer	Oxyde d'aluminium Haute performance Décapage Bois nu Métaux, plastiques Peinture Vernis Laque
Varnish / Lacquer Vernis / laque	#1748 	150 to / à 400 Silicone Carbide Varnish Lacquer	Carbure de silicium Vernis Laque
Wet / Dry Humide / à sec	#1713 	80 to / à 1200 Silicone Carbide Wet / Dry Body Work / Lacquer	Carbure de silicium Humide / à sec Carrosserie / Laque
Metal Métal	#2680 	60 - 80 - 120 Emery Cloth Metal	Toile d'émeri Métaux
Drywall Plâtre	#1786 	80 to / à 150 Silicone Carbide Drywall and plaster	Carbure de silicium Murs secs et plâtre
Drywall Plâtre	#7000 	80 to / à 220 Silicone Carbide Drywall and plaster	Carbure de silicium Murs secs et plâtre



**PAINT
PEINTURE**





ABRASIFS J.J.S INC.

4' GONDOLA / GONDOLE 4'



Pour mieux vous servir, nous offrons le service de planogramme selon vos besoins!
To serve you better, we offer the service of planogram according to your needs!



Wood / Economic Bois / Économique



Advantages:

- Specially developed for hand sanding
- Gives an excellent finish on surfaces
- Economical product

Structure:

- Aluminum Oxide / "C" paper backing

Applications:

- Economical choice for bare wood sanding

Avantages:

- Spécifiquement conçu pour le ponçage manuel
- Procure un excellent fini
- Produit économique

Structure:

- Oxyde d'aluminium / support de papier "C"

Applications:

- Choix économique pour le ponçage du bois nu

1902	9" X 11" (230 X 280 mm)		Aluminum Oxide Sheets (red) Feuilles de corindon (rouge)		Envelope Enveloppe
4 / Pack 4 / Paquet	Grit Grain	Part Number No produit	UPC Code Code UPC	Quantity / Masterpack* Quantité / Carton maître	Quantity / Envelope Quantité / Enveloppe
	Ass.	55425	797966755425	10	4
	060	42456	797966742456	10	3
	080	42463	797966742463	10	3
	100	42470	797966742470	10	3
	120	42418	797966742418	10	4
	180	42425	797966742425	10	4
	220	42432	797966742432	10	4

* Masterpack : number of envelopes per case
Carton Maître: nombre d'enveloppes par caisse

Assorted grits:

- 2 sheets, grit 80
- 1 sheet, grit 120
- 1 sheet, grit 220

Grains assortis:

- 2 feuilles, grain 80
- 1 feuille, grain 120
- 1 feuille, grain 220

1902	9" X 11" (230 X 280 mm)		Aluminum Oxide Sheets (red) Feuilles avec oxyde d'aluminium (rouge)		Contractor Pack Entrepreneur
25 / Pack 25 / Paquet	Grit Grain	Part Number No produit	UPC Code Code UPC	Quantity / Masterpack* Quantité / Carton maître	Quantity / Envelope Quantité / Enveloppe
	Ass.	57498	797966757498	8	25
	060	57450	797966757450	8	25
	100	57467	797966757467	8	25
	150	57474	797966757474	8	25
	220	57481	797966757481	8	25

* Masterpack : number of envelopes per case
Carton Maître: nombre d'enveloppes par caisse

Assorted grits:

- 6 sheets, grit 060
- 6 sheets, grit 100
- 7 sheets, grit 150
- 6 sheets, grit 220

Grains assortis:

- 6 feuilles, grain 060
- 6 feuilles, grain 100
- 7 feuilles, grain 150
- 6 feuilles, grain 220



Wood / Economic Bois / Économique



1902	9" X 11" (230 X 280 mm)		Aluminum Oxide Sheets (red) Feuilles avec oxyde d'aluminium (rouge)		Bulk Vrac
	Grit Grain	Part Number No produit	UPC Code (unit) Code UPC (unité)	Quantity / Case Quantité / Caisse	
	040	18649	7611123318649	400	50
	060	18670	7611123318670	600	50
	080	18700	7611123318700	800	50
	100	18731	7611123318731	900	50
	120	18762	7611123318762	1200	50
	150	18793	7611123318793	1300	50
	180	19189	7611123319189	1400	50
	220	18823	7611123318823	1500	50
	240	18854	7611123318854	1500	50

Stackable Display for 9" X 11" Sheets Présentoir superposable pour feuilles 230 X 280 mm



Part Number / No produit
PR.8131.TOP

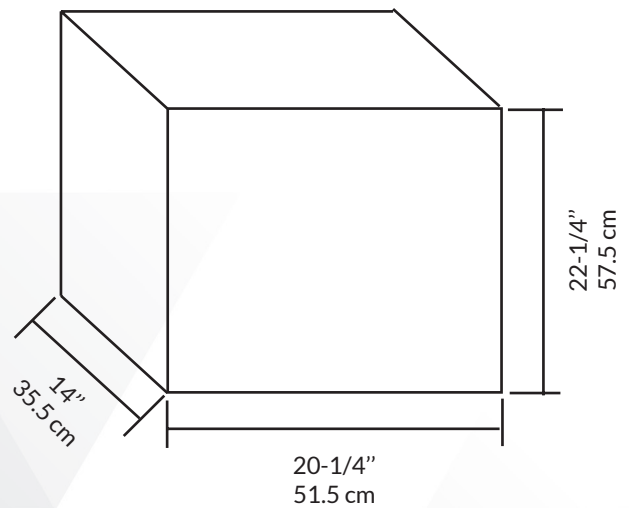

Varnish and Lacquer Sanding Ponçage des vernis et laques



Advantages:

- Specially developed for hand sanding
- Gives an excellent finish
- Reduced clogging due to stearate coating

Structure:

- Silicon carbide / "A" paper backing

Applications:

- Excellent choice for intermediate sanding of varnish and for denibbing lacquers

Advantages:

- Spécifiquement conçu pour le ponçage manuel
- Procure un excellent fini
- Encrassement réduit grâce au stéarate

Structure:

- Carbure de silicium / support de papier "A"

Applications:

- Excellent choix pour le ponçage intermédiaire des vernis et des laques

1748	9" X 11" (230 X 280 mm)		Silicon Carbide Sheets (grey) Feuilles au carbure de silicium (gris)		Envelope Enveloppe
4 / Pack 4 / Paquet	Grit Grain	Part Number No produit	UPC Code Code UPC	Quantity / Masterpack* Quantité / Carton maître	Quantity / Envelope Quantité / Enveloppe
	Ass.	57115	797966757115	10	4
	180	42555	797966742555	10	4
	220	42562	797966742562	10	4
	320	42579	797966742579	10	4

* Masterpack : number of envelopes per case
Carton Maître: nombre d'enveloppes par caisse

Assorted grits:

- 1 sheet, grit 180
- 2 sheets, grit 220
- 1 sheet, grit 320

Grains assortis:

- 1 feuille, grain 180
- 2 feuilles, grain 220
- 1 feuille, grain 320

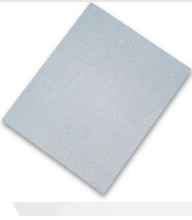
1748	9" X 11" (230 X 280 mm)		Silicon Carbide Sheets (grey) Feuilles au carbure de silicium (gris)		Bulk Vrac
	Grit Grain	Part Number No produit	UPC Code (unit) Code UPC (unité)	Quantity / Case Quantité / Caisse	Quantity / Sleeve Quantité / Paquet
	150	61194	7611123061194	500	50
	180	61224	7611123061224	500	50
	220	61255	7611123061255	500	50
	240	61286	7611123061286	500	50
	280	61316	7611123061316	500	50
	320	61347	7611123061347	500	50
	400	61378	7611123061378	500	50

2-3/4" X 5" (70 X 125 mm)		Hand Sanding Block with slit Bloc de ponçage manuel avec rainure		
Grit Grain	Part Number No produit	UPC Code Code UPC	Quantity / Case Quantité / Caisse	Quantity / sleeve Quantité / paquet
	91641	7611123091641		1



All Purpose Sanding - High Performance

Ponçage tout usage - Haute performance



Advantages:

- Specially developed for hand sanding
- Gives an excellent finish on surfaces
- Reduced clogging due to stearate coating

Structure:

- Aluminum Oxide / paper backing

Applications:

- Excellent choice for dry sanding

Avantages:

- Spécifiquement conçu pour le ponçage manuel
- Procure un excellent fini
- Encrassement réduit grâce au stéarate

Structure:

- Oxyde d'aluminium / support de papier

Applications:

- Excellent choix pour le ponçage à sec

1960	9" X 11" (230 X 280 mm)		Aluminum Oxide Sheets (yellow) Feuilles de corindon (jaune)		Envelope Enveloppe
4 - 5 / Pack 4 - 5 / Paquet	Grit Grain	Part Number No produit	UPC Code Code UPC	Quantity / Masterpack* Quantité / Carton maître	Quantity / Envelope Quantité / Enveloppe
	Ass.	55418	797966755418	10	5
	040	42494	797966742494	10	4
	060	42500	797966742500	10	4
	080	42517	797966742517	10	4
	100	42487	797966742487	10	4
	120	42524	797966742524	10	5
	150	58006	797966758006	10	5
	180	42531	797966742531	10	5
	220	42548	797966742548	10	5

Assorted grits:

- 2 sheets, grit 080
- 1 sheet, grit 220

Grains assortis:

- 2 feuilles, grain 080
- 1 feuille, grain 220

1960	9" X 11" (230 X 280 mm)		Aluminum Oxide Sheets (yellow) Feuilles de corindon (jaune)		Bulk Vrac
	Grit Grain	Part Number No produit	UPC Code (unit) Code UPC (unité)	Quantity / Case Quantité / Caisse	Quantity / Sleeve Quantité / Paquet
	040	62518	7611123162518	250	25
	060	62525	7611123162525	250	50
	080	62532	7611123162532	250	50
	100	62549	7611123162549	500	50
	120	62556	7611123162556	500	50
	150	62563	7611123162563	500	50
	180	62570	7611123162570	500	100
	220	62587	7611123162587	500	100
	240	62594	7611123162594	500	100
	280	62600	7611123162600	500	100
	320	62617	7611123162617	500	100
	400	56705	7611123256705	500	100
	500	56736	7611123256736	500	100
	600	89266	7611123089266	500	100



Wet or Dry Sanding Ponçage humide ou à sec



Advantages:

- Specially developed for wet hand sanding
- Gives an excellent finish on surfaces
- Reduced clogging when used wet

Structure:

- Silicone carbide / paper backing
- Must be soaked few minutes before use

Applications:

- Excellent choice for metal wet sanding
- Body work / Lacquer

Avantages:

- Spécifiquement conçu pour le ponçage à l'eau
- Procure un excellent fini
- Encrassement réduit lorsqu'utilisé humide

Structure:

- Carbure de silicium / support de papier
- Doit être trempé quelques minutes avant l'utilisation

Applications:

- Excellent choix pour le ponçage humide des métaux
- Carrosserie et laque

1713	9" X 11" (230 X 280 mm)		Silicon Carbide Sheets (black) Feuilles avec carbure de silicium (noir)		Envelope Enveloppe	
	4 / Pack 4 / Paquet	Grit Grain	Part Number No produit	UPC Code Code UPC	Quantity / Masterpack* Quantité / Carton maître	Quantity / Envelope Quantité / Enveloppe
		220	57085	797966757085	10	4
		320	42616	797966742616	10	4
		400	42623	797966742623	10	4
		600	42630	797966742630	10	4

* Masterpack : number of envelopes per case
Carton Maître: nombre d'enveloppes par caisse

1713	9" X 11" (230 X 280 mm)		Silicon Carbide Sheets (black) Feuilles avec carbure de silicium (noir)		Bulk Vrac	
		Grit Grain	Part Number No produit	UPC Code (unit) Code UPC (unité)	Quantity / Case Quantité / Caisse	Quantity / Sleeve Quantité / Paquet
		120	24350	7611123324350	500	50
		150	24411	7611123324411	500	50
		180	24442	7611123324442	500	50
		220	24305	7611123324305	500	50
		240	24251	7611123324251	500	50
		320	18496	7611123318496	500	50
		400	18526	7611123318526	500	50
		600	18557	7611123318557	500	50
		800	23964	7611123323964	500	50
		1000	22868	7911123322868	500	50
		1200	18588	7611123318588	500	50



Metal Sanding Ponçage des métaux



Advantages:

- Specially developed for hand sanding
- Gives an excellent finish on surfaces

Structure:

- Emery / Cotton backing

Applications:

- Excellent choice for metal sanding

Avantages:

- Spécifiquement conçu pour le ponçage manuel
- Procure un excellent fini

Structure:

- Émeri / support de toile

Applications:

- Excellent choix pour le ponçage des métaux

2680		9" X 11" (230 X 280 mm)		Emery Cloth Sheets (black) Toile d'émeri en feuille (noir)		Envelope Enveloppe	
3 / Pack 3 / Paquet	Grit Grain	Part Number No produit	UPC Code Code UPC	Quantity / Masterpack* Quantité / Carton maître	Quantity / Envelope Quantité / Enveloppe		
	Ass.	54381	797966754381	10	3		
	060	56507	797966756507	10	3		
	080	54305	797966754305	10	3		
	120	54398	797966754398	10	3		

* Masterpack : number of envelopes per case
Carton Maitre: nombre d'enveloppes par caisse

Assorted grits:

- 1 sheet, grit 060
- 1 sheet, grit 080
- 1 sheet, grit 120

Grains assortis:

- 1 feuille, grain 060
- 1 feuille, grain 080
- 1 feuille, grain 120

2680		9" X 11" (230 X 280 mm)		Emery Cloth Sheets (black) Toile d'émeri en feuille (noir)		Bulk Vrac	
	Grit Grain	Part Number No produit	UPC Code (unit) Code UPC (unité)	Quantity / Case Quantité / Caisse	Quantity / Sleeve Quantité / Paquet		
	060	09769	7033970009769	500	50		
	080	09752	7033970009752	500	50		
	120	09745	7033970009745	500	50		

Hand Sanding Block Bloc de ponçage manuel



2-3/4" X 5" (70 X 125 mm)		Hand Sanding Block with slit Bloc de ponçage manuel avec rainure			siafast Hand Sanding Block Bloc de ponçage manuel siafast		
	Part N. No prod.	UPC Code Code UPC	Qty / sleeve Qté / paquet		Part N. No prod.	UPC Code Code UPC	Qty / sleeve Qté / paquet
	91641	7611123091641	1		0020.0342		1



siasoft Contour Sponges

Éponges siasoft pour contour



Advantages:

- Very good removal rate and long life
- Produces fine finish due to special foam backing
- Easily adaptable to contours and rounded areas
- Foam backing gives a good grip while evenly distributing pressure

Structure:

- Aluminum oxide / Silicon carbide
- Stearate anticlogging coating

Applications:

- Excellent choice for dry hand sanding of special contours and shapes (metals, woods, plastics)

Avantages:

- Haut taux d'enlèvement et longue durée de vie
- Finition super fine due à l'unique support en mousse
- Adapté pour contours et arrondis
- Le support en mousse procure une bonne prise en main tout en répartissant la pression

Structure:

- Oxyde d'aluminium / carbure de silicium
- Enduit anti-encrassement à base de stéarate

Applications:

- Excellent choix pour le ponçage à sec des contours et arrondis spéciaux (métaux, bois et plastiques)

1748		4-1/2" X 5-1/2" (115 X 140 mm)		Paper Backing (silicon carbide, grey) Support de papier (carbure de silicium, gris)		Enveloppe Enveloppe
2 / Pack 2 / Paquet	Grit Grain	Part Number No produit	UPC Code Code UPC	Quantity / Masterpack* Quantité / Carton maître	Quantity / Enveloppe Quantité / Enveloppe	
	180	53230	797966753230	10	2	
	220	53247	797966753247	10	2	
	280	53254	797966753254	10	2	
	320	54367	797966754367	10	2	
	400	54374	797966754374	10	2	

* Masterpack : number of envelopes per case
Carton Maître: nombre d'enveloppes par caisse

2951		4-1/2" X 5-1/2" (115 X 140 mm)		Cloth Backing (aluminum oxide, red) Support en toile (oxyde d'aluminium, rouge)		Enveloppe Enveloppe
2 / Pack 2 / Paquet	Grit Grain	Part Number No produit	UPC Code Code UPC	Quantity / Masterpack* Quantité / Carton maître	Quantity / Enveloppe Quantité / Enveloppe	
	080	52172	797966752172	10	2	
	100	52189	797966752189	10	2	
	120	52196	797966752196	10	2	
	150	52103	797966752103	10	2	
	180	53216	797966753216	10	2	
	220	53223	797966753223	10	2	

* Masterpack : number of envelopes per case
Carton Maître: nombre d'enveloppes par caisse



Hook & Loop Strips and Hand Sanding Block Feuilles auto-agrippantes et bloc de ponçage



All Purpose Sanding - High Performance
Ponçage tout usage - Haute performance

Advantages:

- Specially developed for hand sanding
- Gives an excellent finish on surfaces
- Reduced clogging due to stearate coating

Structure:

- Aluminum Oxide / paper backing

Applications:

- Excellent choice for dry sanding

Avantages:

- Spécifiquement conçu pour le ponçage manuel
- Procure un excellent fini
- Encrassement réduit grâce au stéarate

Structure:

- Oxyde d'aluminium / support de papier

Applications:

- Excellent choix pour le ponçage à sec

1960	2-3/4" X 5" (70 X 125 mm)		Starting Kit Ensemble de départ		Envelope Enveloppe
	Grit Grain	Part Number No produit	UPC Code Code UPC	Quantity / Masterpack* Quantité / Carton maître	Quantity / Envelope Quantité / Enveloppe
		42012	797966742012		1
	Included in the Starting Kit:			Inclus dans l'ensemble de départ:	
		- Two sided hand sanding block		- Bloc de ponçage sur deux côtés	
		- 1 sheet of grits 220, 150, 120 & 80		- 1 feuille de grains 220, 150, 120 et 80	

1960	2-3/4" X 5" (70 X 125 mm)		Aluminum Oxide Sheets (siafast, yellow) Feuilles oxyde d'aluminium (siafast, jaune)		Envelope Enveloppe
4 / Pack 4 / Paquet	Grit Grain	Part Number No produit	UPC Code Code UPC	Quantity / Masterpack* Quantité / Carton maître	Quantity / Envelope Quantité / Enveloppe
	080	42036	797966742036	10	4
	120	42029	797966742029	10	4
	150	42043	797966742043	10	4
	220	42050	797966742050	10	4
	400	42067	797966742067	10	4



sianet Sheets - for sanding without dust! Feuilles sianet - pour un ponçage sans poussière!



Advantages:

- Full-surface dust extraction
- No dependence on hole system
- High removal rate without clogging
- High tear resistance thanks to sturdy net backing

Structure:

- 7900 sianet: Aluminum Oxide

Applications:

- Sanding of paints, plasters, varnishes, primers & plastics
- Fine sanding solid wood, veneers, solid surface materials, primer, plaster and plasterboard
- Preparation for polishing on high-gloss surfaces

Advantages:

- Aspiration optimale sans poussière
- Rendement de ponçage élevé sans encrassement
- Utilisable sur tout type de plateau perforé
- Grande résistance au déchirement grâce au support toile réticulé

Structure:

- 7900 sianet: Oxyde d'aluminium

Applications:

- Ponçage de peintures, vernis, mastics, d'apprêts et plastiques
- Ponçage fin de bois massif, contreplaqué, matières minérales, couche d'apprêt, placoplâtre et en fibre de plâtre
- Préparation au fini miroir

7900	2-3/4" x 5" (70 x 125 mm)		Aluminum Oxide (screen) Corindon (treillis)		
	Grit Grain	Part Number No produit	UPC Code (sleeve) Code UPC (paquet)	Quantity / case Quantité / caisse	Quantity / sleeve Quantité / paquet
	080	88980	7611123288980	300	50
	100	89000	7611123289000	300	50
	120	89024	7611123289024	300	50
	150	89048	7611123289048	300	50
	180	89062	7611123289062	300	50
	220	89086	7611123289086	300	50
	240	89109	7611123289109	300	50
	320	89123	7611123289123	300	50
	400	89147	7611123289147	300	50



Strips for Drywall Sanding

Feuilles coupées pour ponçage de placoplâtre



Advantages:

- Specially developed for hand sanding
- Gives an excellent finish on surfaces

Structure:

- Silicon carbide / "C" paper backing

Applications:

- Excellent choice for drywall sanding

Avantages:

- Spécifiquement conçu pour le ponçage manuel
- Procure un excellent fini

Structure:

- Carbure de silicium / support de papier "C"

Applications:

- Excellent choix pour le ponçage du placoplâtre

1786		4-3/16" X 11" (110 X 280 mm)		Silicon Carbide Sheets (black) Feuilles avec carbure de silicium (noir)		Envelope Enveloppe	
5 / Pack 5 / Paquet	Grit Grain	Part Number No produit	UPC Code Code UPC	Quantity / Masterpack* Quantité / Carton maître	Quantity / Envelope Quantité / Enveloppe		
	080	56569	797966756569	10	5		
	100	56576	797966756576	10	5		
	120	56583	797966756583	10	5		
	150	56590	797966756590	10	5		

* Masterpack : number of envelopes per case
Carton Maitre: nombre d'enveloppes par caisse

1786		4-3/16" X 11" (110 X 280 mm)		Silicon Carbide Sheets (black) Feuilles avec carbure de silicium (noir)		Contractor Pack Entrepreneur	
25 / Pack 25 / Paquet	Grit Grain	Part Number No produit	UPC Code Code UPC	Quantity / Masterpack* Quantité / Carton maître	Quantity / Envelope Quantité / Enveloppe		
	080	57597	797966757597	-	25		
	100	57603	797966757603	-	25		
	120	57610	797966757610	-	25		
	150	57627	797966757627	-	25		

* Masterpack : number of envelopes per case
Carton Maitre: nombre d'enveloppes par caisse

1786		4-3/16" X 11" (110 X 280 mm)		Silicon Carbide Sheets (black) Feuilles avec carbure de silicium (noir)		Bulk Vrac	
	Grit Grain	Part Number No produit	UPC Code (unit) Code UPC (unité)	Quantity / Case Quantité / Caisse	Quantity / Sleeve Quantité / Paquet		
	080	09707	7033970009707	500	25		
	100	09691	7033970009691	500	25		
	120	09684	7033970009684	500	25		
	150	14176	7033970014176	500	25		



1786		3-5/16" X 11" (85 X 280 mm)		Silicon Carbide Sheets (black) Feuilles avec carbure de silicium (noir)		Bulk Vrac	
	Grit Grain	Part Number No produit	UPC Code (unit) Code UPC (unité)	Quantity / case Quantité / caisse	Quantity / sleeve Quantité / paquet		
	080	15913	7033970015913	500	25		
	100	15920	7033970015920	500	25		
	120	15937	7033970015937	500	25		
	150	15944	7033970015944	500	25		



Strips for Drywall Sanding Feuilles coupées pour ponçage de placoplâtre



High Performance - Haute performance

1960		Die Cut Sheets (aluminum oxide, yellow) Feuilles coupées (oxyde d'aluminium, jaune)			Bulk Vrac
Grit Grain	Part Number No produit	UPC Code (sleeve) Code UPC (paquet)	Quantity / Case Quantité / Caisse	Quantity / Sleeve Quantité / Paquet	
3-5/16" x 11" (85 x 280 mm)					
	100	52347	7613387652347	500	100
	120	52354	7613387652354	500	100
	150	52361	7613387652361	500	100
	180	52378	7613387652378	500	100
	220	52385	7613387652385	500	100
4-3/16" x 11" (107 x 281 mm)					
	080	42805	7613387642805	500	100
	100	42812	7613387642812	500	100
	120	29479	7613387629479	500	100
	150	42829	7613387642829	500	100
	180	42836	7613387642836	500	100
	220	42843	7613387642843	500	100



siasoft for Drywall Sanding

siasoft pour ponçage de placoplâtre



2951

siasoft Rolls (aluminum oxide, red)
Rouleaux siasoft (oxyde d'aluminium, rouge)



Grit Grain	Part Number No produit	UPC Code Code UPC	Part Number No produit	UPC Code Code UPC	Quantity / sleeve Quantité / paquet
3-1/2" x 11 yds (90 mm x 10 m)			4-1/2" x 11 yds (115 mm x 10 m)		
080	72927	7611123272927	05362	7611123105362	1
100	33409	7611123233409	05379	7611123105379	1
120	04669	7611123204669	05386	7611123105386	1
150	03440	7611123203440	05393	7611123105393	1
180	13753	7611123213753	05409	7611123105409	1
220	15849	7611123215849	05416	7611123105416	1



Screens for Drywall Sanding

Treillis pour ponçage de placoplâtre



Advantages:

- Specially developed for vacuum
- Gives an excellent finish on surfaces

Structure:

- Silicon Carbide / screen

Applications:

- Excellent choice for sanding drywall

Advantages:

- Spécifiquement conçu pour l'aspiration
- Procure un excellent fini

Structure:

- Carbure de silicium / treillis

Applications:

- Excellent choix pour le ponçage de placoplâtre

7000		4-3/16" X 11" (110 X 280 mm)		Silicon Carbide Screens (black) Treillis avec carbure de silicium (noir)		Enveloppe Enveloppe
2 / Pack 2 / Paquet	Grit Grain	Part Number No produit	UPC Code Code UPC	Quantity / Masterpack* Quantité / Carton maître	Quantity / Enveloppe Quantité / Enveloppe	
	080	51038	797966751038	10	2	
	100	51045	797966751045	10	2	
	120	51052	797966751052	10	2	
	150	52165	797966752165	10	2	

* Masterpack : number of envelopes per case
Carton Maitre: nombre d'enveloppes par caisse

7000		4-3/16" X 11" (110 X 280 mm)		Silicon Carbide Screens (black) Treillis avec carbure de silicium (noir)		Contractor Pack Entrepreneur
10 / Pack 10 / Paquet	Grit Grain	Part Number No produit	UPC Code Code UPC	Quantity / Masterpack* Quantité / Carton maître	Quantity / Enveloppe Quantité / Enveloppe	
	080	57559	797966757559	-	10	
	100	57566	797966757566	-	10	
	120	57573	797966757573	-	10	
	150	57580	797966757580	-	10	

* Masterpack : number of envelopes per case
Carton Maitre: nombre d'enveloppes par caisse

7000		4-3/16" X 11" (110 X 280 mm)		Silicon Carbide Screens (black) Treillis avec carbure de silicium (noir)		Bulk Vrac
	Grit Grain	Part Number No produit	UPC Code (unit) Code UPC (unité)	Quantity / Case Quantité / Caisse	Quantity / sleeve Quantité / paquet	
	080	70080	797966757733	250	50	
	100	70100	797966757740	250	50	
	120	70120	797966757757	250	50	
	150	70150	797966757764	250	50	
	220	70220	797966757771	250	50	



Screens for Drywall Sanding Treillis pour ponçage de placoplâtre



7000	3-5/16" X 11" (85 X 280 mm)		Silicon Carbide Screens (black) Treillis avec carbure de silicium (noir)		
	Grit Grain	Part Number No produit	UPC Code (unit) Code UPC (unité)	Quantity / Case Quantité / Caisse	Quantity / sleeve Quantité / paquet
	080	70083	N/A	250	50
	100	70103	N/A	250	50
	120	70123	N/A	250	50



Economical Sanding Sponges

Éponges de ponçage économiques



Advantages:

- Good removal rate and long life
- Flexible due to sponge backing
- Designed for curves & profiles
- Can be used wet or dry

Structure:

- Aluminum oxide applied on sponge

Applications:

- Excellent choice for dry or wet hand sanding

Advantages:

- Haut taux d'enlèvement et longue durée de vie
- Flexibilité due au support en mousse
- Pré adapté aux contours et aux arrondis
- Peut-être utilisé sec ou humide

Structure:

- Oxyde d'aluminium appliqué sur une éponge

Applications:

- Excellent choix pour le ponçage manuel à sec ou humide

2-3/4" X 3-3/4" X 1" (69 X 98 X 26 mm)		Sanding Sponges Éponges de ponçage			Envelope Enveloppe
1 / Pack 1 / Paquet	Grade Grade	Part Number No produit	UPC Code Code UPC	Quantity / Masterpack* Quantité / Carton maître	Qty / Envelope Qté / Enveloppe
	Medium / Coarse Moyen / Gros	44452	797966344452	36	1
	Medium / Medium Moyen / Moyen	44810	797966344810	36	1
	Medium / Fine Moyen / Fin	44476	797966344476	36	1
	Fine / Fine Fin / Fin	44612	797966344612	36	1

* Masterpack : number of envelopes per case
Carton Maitre: nombre d'enveloppes par caisse

2-3/4" X 3-3/4" X 1" (69 X 98 X 26 mm)		Sanding Sponges Éponges de ponçage			Envelope Enveloppe
5 / Pack 5 / Paquet	Grade Grade	Part Number No produit	UPC Code Code UPC	Quantity / Masterpack* Quantité / Carton maître	Qty / Envelope Qté / Enveloppe
	Medium / Fine Moyen / Fin	57788	797966757788	5	5

* Masterpack : number of envelopes per case
Carton Maitre: nombre d'enveloppes par caisse

2-3/4" X 10" X 1" (75 X 225 X 25 mm)		Oversize Sanding Sponges Éponges de ponçage surdimensionnées			Envelope Enveloppe
1 / Pack 1 / Paquet	Grade Grade	Part Number No produit	UPC Code Code UPC	Quantity / Masterpack* Quantité / Carton maître	Quantity / sleeve Quantité / paquet
	Medium / Fine Moyen / Fin	57443	797966757443	36	1

* Masterpack : number of envelopes per case
Carton Maitre: nombre d'enveloppes par caisse



Economical Sanding Sponges

Éponges de ponçage économiques



		3" X 5" X 1" (75 X 125 X 25 mm)		Dual Angle Sanding Sponges Éponges de ponçage à angle double		Envelope Enveloppe	
1 / Pack 1 / Paquet	Grade Grade	Part Number No produit	UPC Code Code UPC	Quantity / Masterpack* Quantité / Carton maître	Qty / Envelope Qté / Enveloppe		
	Medium / Coarse Moyen / Gros	57436	797966757436	24	1		
	Medium / Fine Moyen / Fin	57405	797966757405	24	1		
	Fine / Fine Fin / Fin	57429	797966757429	24	1		
<p>* Masterpack : number of envelopes per case Carton Maitre: nombre d'enveloppes par caisse</p>							

		4" x 4-3/4 x 1/2" (97 x 120 x 12 mm)		Standard Pads (aluminum oxide, blue) Éponges minces (corindon, bleu)		Envelope Enveloppe	
2 / Pack 2 / Paquet	Grade Grade	Part Number No produit	UPC Code Code UPC	Quantity / Masterpack* Quantité / Carton maître	Qty / Envelope Qté / Enveloppe		
	0060 Med. / Moy	57634	797966757634	10	2		
	0100 Fine / Fin	57641	797966757641	10	2		
	0180 S-fine / S-fin	57658	797966757658	10	2		
<p>* Masterpack : number of envelopes per case Carton Maitre: nombre d'enveloppes par caisse</p>							



Coloured Sponges Éponges de couleur



Advantages:

- colour coding to facilitate use of sanding grits
- Highly flexible
- Compact
- For WET or DRY utilisations
- No acid solvent odour
- No folds, no kinks
- Consistent sanding pattern
- Suitable for highly versatile use on plastics, composites, paints, varnishes, old lacquers, fillers, primers, wood

Structure:

- Aluminum oxide applied on sponge

Applications:

- Excellent choice for dry or wet hand sanding

Avantages:

- Sélection des grains facilité grâce au code de couleurs
- Grande souplesse
- Compacte
- Utilisable à l'eau ou à sec
- Permet une utilisation sans odeur
- Lisse
- Consistance de sablage
- Polyvalent: plastiques, composites, peintures, laques, anciennes peintures, apprêts, couches de fond, bois, vernis

Structure:

- Oxyde d'aluminium appliqué sur une éponge

Applications:

- Excellent choix pour le ponçage manuel à sec ou humide

7990 Hard block Bloc dur							ultrafine ultrafin	ultrafine - ultrafin
							superfine superfin	superfine - superfin
7991 Soft block Bloc mou	fine fin							fine - fin
	medium moyen							medium - moyen
7983 Flex pad Tampon flexible	coarse grossier							coarse - grossier
	180	220	240	280	320	400	500	600
1960 siarexx	180	220	240	280	320	400	500	600

7990	2-3/4" X 3-3/4" X 1" (69 X 98 X 26 mm)	Sanding Sponges Éponges de ponçage			Enveloppe Enveloppe
3 / Pack 3 / Paquet	Grade Grade	Part Number No produit	UPC Code Code UPC	Quantity / Masterpack* Quantité / Carton maître	Qty / Enveloppe Qté / Enveloppe



Assorted / assorti

58198

797966758198

5

3

* Masterpack : number of envelopes per case
Carton Maître: nombre d'enveloppes par caisse



Coloured Sanding Sponges with one angle Éponges de couleur avec un angle



7990	2-3/4" X 3-3/4" X 1" (69 X 98 X 26 mm)	Sanding Sponges with one angle Éponges de ponçage avec un angle			Envelope Enveloppe
3 / Pack 3 / Paquet	Grade Grade	Part Number No produit	UPC Code Code UPC	Quantity / Masterpack* Quantité / Carton maître	Qty / Envelope Qté / Enveloppe



Assorted / assortie **58204** 797966758204 5 3

* Masterpack : number of envelopes per case
Carton Maitre: nombre d'enveloppes par caisse

Double face Coloured Thin Pads Éponges de couleur mince à double face



7983	3-3/4" X 4-3/4" X 1/2" (98 X 120 X 13 mm)	Sanding Sponges Éponges de ponçage			Envelope Enveloppe
3 / Pack 3 / Paquet	Grade Grade	Part Number No produit	UPC Code Code UPC	Quantity / Masterpack* Quantité / Carton maître	Qty / Envelope Qté / Enveloppe



Assorted / assorti **58211** 797966758211 5 3

* Masterpack : number of envelopes per case
Carton Maitre: nombre d'enveloppes par caisse



Rolls for all Purpose Sanding

Rouleaux pour ponçage tout usage



Advantages:

- Specially developed for power tool hand sanding
- Gives an excellent finish on surfaces
- Reduced clogging due to stearate coating

Structure:

- Aluminum Oxide / paper backing

Applications:

- Excellent choice for dry sanding (drywall, wood, plastics, fiberglass, paints & varnishes)

Avantages:

- Spécifiquement conçu pour le ponçage manuel
- Procure un excellent fini
- Encrassement réduit grâce au stéarate

Structure:





- Oxyde d'aluminium / support de papier

Applications:

- Excellent choix pour le ponçage à sec (placoplâtre, bois, plastiques, fibre de verre, métaux, peintures et vernis)

1960

Paper Rolls (aluminum oxide, yellow) Rouleaux papier (oxyde d'aluminium, jaune)

	Grit Grain	Part Number No produit	UPC Code Code UPC	Quantity / Case Quantité / Caisse	Quantity / Sleeve Quantité / Paquet
3-12/3" x 16' (95 mm x 5 m)					
	060	69531	7611123169531	-	1
	080	69548	7611123169548	-	1
	120	69555	7611123169555	-	1
	180	69562	7611123169562	-	1
4-1/2" x 16' (115 mm x 5 m)					
	080	29981	7613387629981	-	1
	120	29998	7613387629998	-	1
	180	30017	7613387630017	-	1
	240	30024	7613387630024	-	1
3-2/3" x 55 yds (95 mm x 50 m)					
	080	54032	7611123154032	-	1
	100	54049	7611123154049	-	1
	120	54056	7611123154056	-	1
	150	54063	7611123154063	-	1
	180	54070	7611123154070	-	1
	220	54087	7611123154087	-	1
4-1/2" x 55 yds (115 mm x 50 m)					
	060	54278	7611123154278	-	1
	080	54285	7611123154285	-	1
	100	54292	7611123154292	-	1
	120	54308	7611123154308	-	1
	150	54315	7611123154315	-	1
	180	54322	7611123154322	-	1
	220	54339	7611123154339	-	1
	240	54346	7611123154346	-	1
	280	54353	7611123154353	-	1
	400	54377	7611123154377	-	1



sianet Rolls

Rouleaux sianet



Advantages:

- Full-surface dust extraction
- No dependence on hole system
- High removal rate without clogging
- High tear resistance thanks to sturdy net backing

Structure:

- 7900 sianet: Aluminum Oxide

Applications:

- Sanding of paints, plasters, varnishes primers & plastics
- Fine sanding solid wood, veneers, solid surface materials, primer, plaster and plasterboard
- Preparation for polishing on high-gloss surfaces

Avantages:

- Aspiration optimale sans poussière
- Utilisable sur tous les types de plateaux perforés
- Rendement de ponçage élevé sans encrassement
- Grande résistance aux déchirures grâce au support de toile réticulé

Structure:

- 7900 sianet: Oxyde d'aluminium

Applications:

- Ponçage de peintures, vernis, mastics, apprêts et plastiques
- Ponçage fin du bois massif, contreplaqué, matières minérales, couche d'apprêt, placoplâtre et fibre de plâtre
- Préparation des finis miroirs

7900	4-1/2" x 11 yds (115 mm x 10m)		Aluminum Oxide (screen) Corindon (treillis)		
	Grit Grain	Part Number No produit	UPC Code Code UPC	Quantity / Case Quantité / Caisse	Quantity / Sleeve Quantité / Paquet
	080	90181	7611123290181	-	1
	100	90204	7611123290204	-	1
	120	90228	7611123290228	-	1
	150	90242	7611123290242	-	1
	180	90266	7611123290266	-	1
	220	90280	7611123290280	-	1
	240	90303	7611123290303	-	1
	320	90327	7611123290327	-	1
	400	90341	7611123290341	-	1



Handpads Tampons abrasifs



Advantages:

- Uniform finish without distortion
- May be used on both sides
- Resistant against chemicals cleaners

Structure:

- Aluminum oxide / Silicon carbide
- 3-D fiber fleece
- Flexible and durable

Applications:

- Excellent choice for rust, paint, primer, and lacquer removal
- Wet and dry applications

Avantages:

- Finition uniforme sans distortion
- Utilisable des deux côtés
- Résistant aux détergents

Structure:

- Oxyde d'aluminium / carbure de silicium
- Nylon non tissé
- Flexible et durable

Applications:

- Excellent choix pour l'enlèvement de rouille, peintures et laques
- Utilisable à sec ou à l'eau

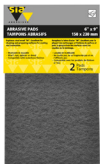

6120	6" X 9" (150 X 230 mm)	Handpads Tampons abrasifs			Envelope Enveloppe
2 / Pack 2 / Paquet	Grit Grain	Part Number No produit	UPC Code Code UPC	Quantity / Masterpack* Quantité / Carton maître	Qty / Envelope Qté / Enveloppe
	100 Coarse (Green) 100 Grossier (Vert)	57092	797966757092	10	2
	320 Fine (Maroon) 320 Fin (Marron)	57108	797966757108	10	2
	600 Extra fine (grey) 600 Extra fin (gris)	57078	797966757078	10	2

* Masterpack : number of envelopes per case
Carton Maître: nombre d'enveloppes par caisse





POWER TOOL SANDING
PONÇAGE MÉCANIQUE





ABRASIFS J.J.S INC.

4' GONDOLA / GONDOLE 4'

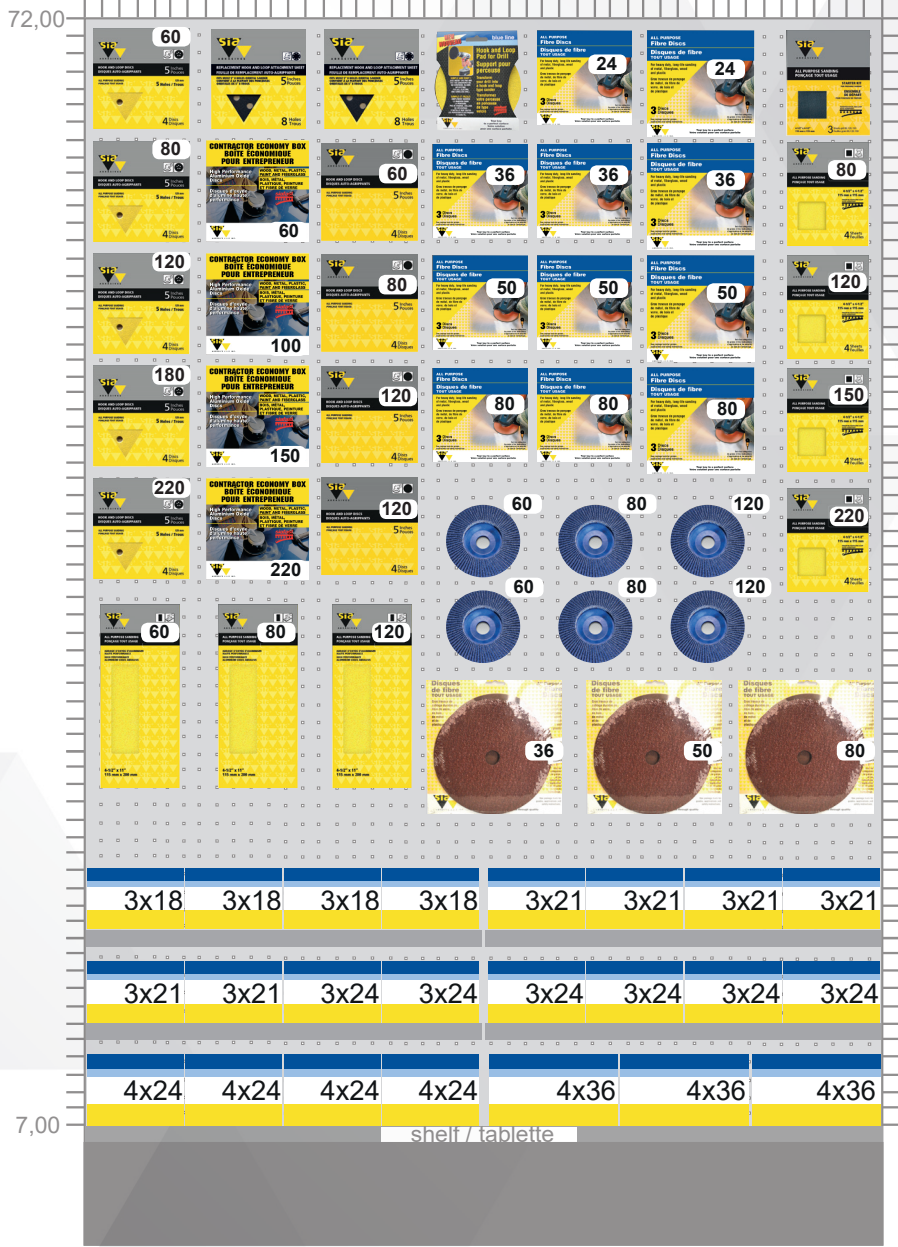

Pour mieux vous servir, nous offrons le service de planogramme selon vos besoins!
To serve you better, we offer the service of planogram according to your needs!

Kim, modifier la couleur des boites de bandes



Sanding Belts Bandes de ponçage



Widths: 1" & 2-1/2"
Largeurs: 25 & 65 mm

Advantages:

- Very high removal rate / low clogging
- High durability with heavy duty backing
- Optimized belt joints depending upon grit and application

Structure:

- Aluminum oxide
- Resin over resin
- X weight cloth backing

Applications:

- Excellent choice for sanding old paints and varnishes and flattening edges and rabbets

We offer a custom made belt service according to your special needs

Avantages:

- Très haut taux d'enlèvement / faible encrassement
- Longue durée de vie grâce à un support extrêmement robuste
- Joint optimisé selon l'utilisation et le grain

Structure:

- Oxyde d'aluminium
- Double résine
- Support de toile X

Applications:

- Excellent choix pour le ponçage des vieilles peintures et des vernis et pour uniformiser les surfaces

Nous offrons un service de confection pour vos besoins particuliers

		1" X 30" (25 X 760 mm)		Sanding Belts (aluminum oxide, red) Bandes de ponçage (oxyde d'aluminium, rouge)	
3 / Pack 3 / Paquet	Grit Grain	Part Number No produit	UPC Code Code UPC	Quantity / Masterpack* Quantité / Carton maître	Quantity / Envelope Quantité / Enveloppe
	036	41336	797966741336	10	3
	050	41350	797966741350	10	3
	080	41381	797966741381	10	3
	120	41312	797966741312	10	3
	220	41329	797966741329	10	3

* Masterpack : number of envelopes per case
Carton Maitre: nombre d'enveloppes par caisse

		1" X 42" (25 X 1065 mm)		Sanding Belts (aluminum oxide, red) Bandes de ponçage (oxyde d'aluminium, rouge)	
3 / Pack 3 / Paquet	Grit Grain	Part Number No produit	UPC Code Code UPC	Quantity / Masterpack* Quantité / Carton maître	Quantity / Envelope Quantité / Enveloppe
	036	41435	797966741435	10	3
	050	41459	797966741459	10	3
	080	42814	797966742814	10	3
	120	41411	797966741411	10	3
	220	42807	797966742807	10	3

* Masterpack : number of envelopes per case
Carton Maitre: nombre d'enveloppes par caisse

		2-1/2" X 16" (65 X 410 mm)		Sanding Belts (aluminum oxide, red) Bandes de ponçage (oxyde d'aluminium, rouge)	
Bulk Vrac	Grit Grain	Part Number No produit	UPC Code (unit) Code UPC (unité)	Quantity / Case Quantité / Caisse	Quantity / Sleeve Quantité / Paquet
	036	24923	7611123324923	60	10
	050	24473	7611123324473	60	10
	080	24480	7611123324480	60	10
	100	24497	7611123324497	60	10
	120	24954	7611123324954	60	10





Sanding Belts

Bandes de ponçage



Width: 3"
Largeur: 75 mm

3" X 18" (75 X 457 mm)		Sanding Belts (aluminum oxide, red) Bandes de ponçage (oxyde d'aluminium, rouge)			
Bulk Vrac	Grit Grain	Part Number No produit	UPC Code (unit) Code UPC (unité)	Quantity / Case Quantité / Caisse	Quantity / Sleeve Quantité / Paquet
	036	62139	7611123062139	60	10
	050	24985	7611123324985	60	10
	080	24527	7611123324527	60	10
	100	24534	7611123324534	60	10
	120	24541	7611123324541	60	10

3" X 20" (75 X 508 mm)		Sanding Belts (aluminum oxide, red) Bandes de ponçage (oxyde d'aluminium, rouge)			
Bulk Vrac	Grit Grain	Part Number No produit	UPC Code (unit) Code UPC (unité)	Quantity / Case Quantité / Caisse	Quantity / Sleeve Quantité / Paquet
	036	62511	7611123062511	60	10
	040	62535	7611123062535	60	10
	050	62559	7611123062559	60	10
	060	62573	7611123062573	60	10
	080	62597	7611123062597	60	10
	100	62610	7611123062610	60	10
	120	62634	7611123062634	60	10

3" X 21" (75 X 533 mm)		Sanding Belts (aluminum oxide, red) Bandes de ponçage (oxyde d'aluminium, rouge)			
Bulk Vrac	Grit Grain	Part Number No produit	UPC Code (unit) Code UPC (unité)	Quantity / Case Quantité / Caisse	Quantity / Sleeve Quantité / Paquet
	036	24572	7611123324572	60	10
	040	24589	7611123324589	60	10
	050	24596	7611123324596	60	10
	060	24602	7611123324602	60	10
	080	24619	7611123324619	60	10
	100	24626	7611123324626	60	10
	120	24633	7611123324633	60	10

3" X 24" (75 X 610 mm)		Sanding Belts (aluminum oxide, red) Bandes de ponçage (oxyde d'aluminium, rouge)			
Bulk Vrac	Grit Grain	Part Number No produit	UPC Code (unit) Code UPC (unité)	Quantity / Case Quantité / Caisse	Quantity / Sleeve Quantité / Paquet
	036	24695	7611123324695	60	10
	040	24701	7611123324701	60	10
	050	24718	7611123324718	60	10
	060	24725	7611123324725	60	10
	080	24732	7611123324732	60	10
	100	24749	7611123324749	60	10
	120	24756	7611123324756	60	10





Sanding Belts

Bandes de ponçage



Width: 4"
Largeur: 100 mm

4" X 21-3/4" (100 X 552 mm)		Sanding Belts (aluminum oxide, red) Bandes de ponçage (oxyde d'aluminium, rouge)			
Bulk Vrac	Grit Grain	Part Number No produit	UPC Code (unit) Code UPC (unité)	Quantity / Case Quantité / Caisse	Quantity / Sleeve Quantité / Paquet
	036	62658	7611123062658	60	10
	050	62672	7611123062672	60	10
	080	62696	7611123062696	60	10
	100	62719	7611123062719	60	10

4" X 24" (100 X 610 mm)		Sanding Belts (aluminum oxide, red) Bandes de ponçage (oxyde d'aluminium, rouge)			
Bulk Vrac	Grit Grain	Part Number No produit	UPC Code (unit) Code UPC (unité)	Quantity / Case Quantité / Caisse	Quantity / Sleeve Quantité / Paquet
	036	24794	7611123324794	60	10
	040	24800	7611123324800	60	10
	050	24817	7611123324817	60	10
	060	24824	7611123324824	60	10
	080	24831	7611123324831	60	10
	100	24848	7611123324848	60	10
	120	24855	7611123324855	60	10

4" X 36" (100 X 915 mm)		Sanding Belts (aluminum oxide, red) Bandes de ponçage (oxyde d'aluminium, rouge)			
Bulk Vrac	Grit Grain	Part Number No produit	UPC Code (unit) Code UPC (unité)	Quantity / Case Quantité / Caisse	Quantity / Sleeve Quantité / Paquet
	036	24640	7611123324640	60	10
	050	24657	7611123324657	60	10
	080	24664	7611123324664	60	10
	100	24671	7611123324671	60	10
	120	24688	7611123324688	60	10



Sanding Belts Bandes de ponçage



Width: 6"
Largeur: 150 mm

6" X 48" (150 X 1220 mm)		Sanding Belts (aluminum oxide, red) Bandes de ponçage (oxyde d'aluminium, rouge)			
Bulk Vrac	Grit Grain	Part Number No produit	UPC Code (unit) Code UPC (unité)	Quantity / Case Quantité / Caisse	Quantity / Sleeve Quantité / Paquet
	036	63099	7611123063099	60	10
	050	63112	7611123063112	60	10
	060	63136	7611123063136	60	10
	080	63150	7611123063150	60	10
	100	63174	7611123063174	60	10
	120	63198	7611123063198	60	10



Sanding Sheets for Orbital Sanders (1/4 sheet) Feuilles pour ponceuses orbitales (1/4 feuille)



Advantages:

- Specially developed for all purpose dry sanding
- Gives an excellent surface finish
- Reduced clogging due to stearate coating
- Fast and easy to change with siafast hook-and-loop fastening system

Structure:

- Aluminum Oxide grits / stearate coating
- Backing with siafast hook-and-loop fastening system

Applications:

- Excellent choice for dry sanding (drywall, wood, plastics, fiberglass & metals)
- Paint and varnish

Avantages:

- Spécifiquement conçu pour le ponçage à sec
- Procure un excellent fini
- Encrassement réduit grâce au stéarate
- Changement rapide et simple grâce au système auto-agrippant siafast

Structure:

- Grain d'oxyde d'aluminium / enduit stéarate
- Support avec système auto-agrippant siafast

Applications:

- Excellent choix pour le ponçage à sec (placoplâtre, bois, plastiques, fibre de verre et métaux)
- Peinture et vernis

4-1/2" X 4-1/2" (115 X 115 mm)		Starting kit for Orbital Sanders 1/4 sheet Ensemble de départ pour orbitales 1/4 de feuille	Envelope Enveloppe
-----------------------------------	--	--	-----------------------

Grit Grain	Part Number No produit	UPC Code Code UPC	Quantity / Masterpack* Quantité / Carton maître	Quantity / Envelope Quantité / Enveloppe
---------------	---------------------------	----------------------	--	---



siafast

42074

797966742074

10

1

Included in the Starting Kit:

- 1 self-sticking siaklett sheet
- 1 sheet, grit 080
- 1 sheet, grit 120
- 1 sheet, grit 150

* Masterpack : number of envelopes per case
Carton Maitre: nombre d'enveloppes par caisse

Inclus dans l'ensemble de départ:

- 1 feuille siaklett autocollante
- 1 feuille, grain 080
- 1 feuille, grain 120
- 1 feuille, grain 150

1960	4-1/2" X 4-1/2" (115 X 115 mm)		1/4 Sheet for Orbital Sanders 1/4 de feuille pour ponceuses orbitales	Envelope Enveloppe
------	-----------------------------------	--	--	-----------------------

4 / Pack 4 / Paquet	Grit Grain	Part Number No produit	UPC Code Code UPC	Quantity / Masterpack* Quantité / Carton maître	Quantity / Envelope Quantité / Enveloppe
------------------------	---------------	---------------------------	----------------------	--	---



siafast

080	42098	797966742098	10	4
120	42081	797966742081	10	4
150	42104	797966742104	10	4
220	42111	797966742111	10	4
400	42128	797966742128	10	4

* Masterpack : number of envelopes per case
Carton Maitre: nombre d'enveloppes par caisse



Sanding Sheets for Orbital Sanders (1/3 sheet) Feuilles pour ponceuses orbitales (1/3 feuille)



3-2/3" X 9" (93 X 230 mm)		Starting Kit for Orbital Sanders 1/3 sheet Ensemble de départ pour orbitales 1/3 de feuille		Envelope Enveloppe
Grit Grain	Part Number No produit	UPC Code Code UPC	Quantity / Masterpack* Quantité / Carton maître	Quantity / Envelope Quantité / Enveloppe
	42135	797966742135	-	1
 <p>Included in the Starting Kit: - 1 self-sticking siaklett sheet - 1 sheet, grit 080 - 1 sheet, grit 120 - 1 sheet, grit 150</p>			<p>Inclus dans l'ensemble de départ: - 1 feuille siaklett autocollante - 1 feuille, grain 080 - 1 feuille, grain 120 - 1 feuille, grain 150</p>	
<p>* Masterpack : number of envelopes per case Carton Maître: nombre d'enveloppes par caisse</p>				

siafast

1960	3-2/3" X 7-1/2" (93 X 190 mm)		1/3 Sheet for Orbital Sanders 1/3 de feuille pour ponceuses orbitales		Envelope Enveloppe
3 / Pack 3 / Paquet	Grit Grain	Part Number No produit	UPC Code Code UPC	Quantity / Masterpack* Quantité / Carton maître	Quantity / Envelope Quantité / Enveloppe
	080	42159	797966742159	10	3
	120	42142	797966742142	10	3
	150	42166	797966742166	10	3
	220	42173	797966742173	10	3
	400	42180	797966742180	10	3
<p>* Masterpack : number of envelopes per case Carton Maître: nombre d'enveloppes par caisse</p>					

siafast

PLAIN SHEETS - FEUILLES RÉGULIÈRES

1960	3-2/3" X 9" (93 X 230 mm)		1/3 Sheet for Orbital Sanders 1/3 de feuille pour ponceuses orbitales		Envelope Enveloppe
4-5 / Pack 4-5 / Paquet	Grit Grain	Part Number No produit	UPC Code Code UPC	Quantity / Masterpack* Quantité / Carton maître	Quantity / Envelope Quantité / Enveloppe
	Ass.	55449	797966755449	10	5
	060	42371	797966742371	10	4
	080	42364	797966742364	10	4
	120	42357	797966742357	10	5
<p>Assorted grits: - 2 sheets, grit 060 - 1 sheet, grit 080 - 2 sheets, grit 120</p>			<p>Grains assortis: - 2 feuilles, grain 060 - 1 feuille, grain 080 - 2 feuilles, grain 120</p>		

1960	3-2/3" X 9" (93 X 230 mm)		1/3 Sheet Orbital Sanders 1/3 de feuille pour ponceuses orbitales		Bulk Vrac
	Grit Grain	Part Number No produit	UPC Code (unit) Code UPC (unité)	Quantity / Case Quantité / Caisse	Quantity / Sleeve Quantité / Paquet
	060	89273	7611123089273	500	50
	080	89280	7611123089280	600	100
	100	89297	7611123089297	600	100
	120	89303	7611123089303	600	100



Sanding Sheets for Orbital Sanders (1/2 sheet) Feuilles pour ponceuses orbitales (1/2 feuille)



4-1/2" X 11" (115 X 280 mm)		Starting Kit for Orbital Sanders 1/2 sheet Ensemble de départ pour orbitales 1/2 feuille		Envelope Enveloppe
Grit Grain	Part Number No produit	UPC Code Code UPC	Quantity / Masterpack* Quantité / Carton maître	Quantity / Envelope Quantité / Enveloppe
 <p>Included in the Starting Kit: - 1 self-sticking siaklett sheet - 1 sheet, grit 080 - 1 sheet, grit 120 - 1 sheet, grit 150</p>		<p>Inclus dans l'ensemble de départ: - 1 feuille siaklett autocollante - 1 feuille, grain 080 - 1 feuille, grain 120 - 1 feuille, grain 150</p>		1
				42197
* Masterpack : number of envelopes per case Carton Maitre: nombre d'enveloppes par caisse				

siafast

1960		4-1/2" X 9" (115 X 230 mm)		1/2 Sheet for Orbital Sanders 1/2 feuille pour ponceuses orbitales		Envelope Enveloppe
3 / Pack 3 / Paquet	Grit Grain	Part Number No produit	UPC Code Code UPC	Quantity / Masterpack* Quantité / Carton maître	Quantity / Envelope Quantité / Enveloppe	
	080	42210	797966742210	10	3	
	120	42203	797966742203	10	3	
	150	42227	797966742227	10	3	
	220	42234	797966742234	10	3	
	400	42241	797966742241	10	3	
* Masterpack : number of envelopes per case Carton Maitre: nombre d'enveloppes par caisse						

siafast

PLAIN SHEETS - FEUILLES RÉGULIÈRES

1960		4-1/2" X 11" (115 X 280 mm)		1/2 Sheet for Orbital Sanders 1/2 feuille pour ponceuses orbitales		Envelope Enveloppe
4-5 / Pack 4-5 / Paquet	Grit Grain	Part Number No produit	UPC Code Code UPC	Quantity / Masterpack* Quantité / Carton maître	Quantity / Envelope Quantité / Enveloppe	
	Ass.	55456	797966755456	10	5	
	060	42401	797966742401	10	4	
	080	42395	797966742395	10	4	
	120	42388	797966742388	10	5	
<p>Assorted grits: - 2 sheets, grit 060 - 1 sheet, grit 080 - 2 sheets, grit 120</p>		<p>Grains assortis: - 2 feuilles, grain 060 - 1 feuille, grain 080 - 2 feuilles, grain 120</p>				
* Masterpack : number of envelopes per case Carton Maitre: nombre d'enveloppes par caisse						

1960		4-1/2" X 11" (115 X 280 mm)		1/2 Sheet for Orbital Sanders 1/2 feuille pour ponceuses orbitales		Bulk Vrac
	Grit Grain	Part Number No produit	UPC Code (unit) Code UPC (unité)	Quantity / Case Quantité / Caisse	Quantity / Sleeve Quantité / Paquet	
	060	89310	7611123089310	500	50	
	080	89327	7611123089327	600	100	
	100	89334	7611123089334	600	100	
	120	89341	7611123089341	600	100	



5" Sanding Discs no holes

Disques de ponçage 125 mm sans trous



Advantages:

- Specially developed for all purpose dry sanding
- Gives an excellent surface finish
- Reduced clogging due to special coating
- Fast and easy to change with siafast hook-and-loop fastening system

Structure:

- Aluminum Oxide / stearate coating
- Backing with siafast hook-and-loop fastening system

Applications:

- Excellent choice for dry sanding (drywall, wood, plastics, fiberglass & metals)
- Paint and varnish

Avantages:

- Spécifiquement conçu pour le ponçage à sec
- Procure un excellent fini
- Encrassement réduit grâce à un enduit spécial
- Changement rapide et simple grâce au système auto-agrippant siafast

Structure:

- Oxyde d'aluminium / enduit stéarate
- Support avec système auto-agrippant siafast

Applications:

- Excellent choix pour le ponçage à sec (placoplâtre, bois, plastiques, fibre de verre et métaux)
- Peinture et vernis

5" X 1/4" (125 X 6 mm)		Hook and Loop Pad for Drills Support auto-agrippant pour perceuses		Envelope Enveloppe
Grit Grain	Part Number No produit	UPC Code Code UPC	Quantity / Masterpack* Quantité / Carton maître	Quantity / Envelope Quantité / Enveloppe
	57542	797966757542	-	1



* Masterpack : number of envelopes per case
Carton Maitre: nombre d'enveloppes par caisse

1960	5" (125 mm)		Discs (aluminum oxide, siafast, yellow) Disques (oxyde d'aluminium, siafast, jaune)		Envelope Enveloppe
4 / Pack 4 / Paquet	Grit Grain	Part Number No produit	UPC Code Code UPC	Quantity / Masterpack* Quantité / Carton maître	Quantity / Envelope Quantité / Enveloppe
	040	57337	797966757337	10	4
	060	57344	797966757344	10	4
	080	57351	797966757351	10	4
	120	57368	797966757368	10	4
	180	57375	797966757375	10	4
	220	57382	797966757382	10	4
	400	57399	797966757399	10	4

1960	5" (125 mm)		Discs (aluminum oxide, siafast, yellow) Disques (oxyde d'aluminium, siafast, jaune)		Contractor Pack Entrepreneur
25 / Pack 25 / Paquet	Grit Grain	Part Number No produit	UPC Code Code UPC	Quantity / Masterpack* Quantité / Carton maître	Quantity / Envelope Quantité / Enveloppe
	040	57122	797966757122	24	25
	060	57139	797966757139	24	25
	080	57146	797966757146	24	25
	120	57153	797966757153	24	25
	180	57160	797966757160	24	25
	220	57177	797966757177	24	25
	400	57184	797966757184	24	25

* Masterpack : number of envelopes per case
Carton Maitre: nombre d'enveloppes par caisse





5" Sanding Discs with 5 Dust holes

Disques de ponçage 125 mm avec 5 trous d'aspiration



Repl. sheets Feuilles de rempl.	5" - DH5 (125 mm)		Replacement Sheet for Discs Feuille de remplacement pour disques		Envelope Enveloppe
	Grit Grain	Part Number No produit	UPC Code Code UPC	Quantity / Masterpack* Quantité / Carton maître	Quantity / Envelope Quantité / Enveloppe
		51014	797966751014	10	1
	<p><i>siafast</i> * Masterpack : number of envelopes per case Carton Maitre: nombre d'enveloppes par caisse</p>				

1960	5" - DH5 (125 mm)		Discs (aluminum oxide, yellow) Disques (oxyde d'aluminium, jaune)		Envelope Enveloppe
4 / Pack 4 / Paquet	Grit Grain	Part Number No produit	UPC Code Code UPC	Quantity / Masterpack* Quantité / Carton maître	Quantity / Envelope Quantité / Enveloppe
	040	42692	797966742692	10	4
	060	42708	797966742708	10	4
	080	42319	797966742319	10	4
	120	42258	797966742258	10	4
	180	42272	797966742272	10	4
	220	42289	797966742289	10	4
	400	42340	797966742340	10	4
	<p><i>siafast</i> * Masterpack : number of envelopes per case Carton Maitre: nombre d'enveloppes par caisse</p>				

1960	5" - DH5 (125 mm)		Discs (aluminum oxide, yellow) Disques (oxyde d'aluminium, jaune)		Contractor Pack Entrepreneur
25 / Pack 25 / Paquet	Grit Grain	Part Number No produit	UPC Code Code UPC	Quantity / Masterpack* Quantité / Carton maître	Quantity / Envelope Quantité / Enveloppe
	040	57191	797966757191	24	25
	060	57207	797966757207	24	25
	080	57214	797966757214	24	25
	100	57665	797966757665	24	25
	120	57221	797966757221	24	25
	150	57672	797966757672	24	25
	180	57238	797966757238	24	25
	220	57245	797966757245	24	25
	400	57252	797966757252	24	25
	<p><i>siafast</i> * Masterpack : number of envelopes per case Carton Maitre: nombre d'enveloppes par caisse</p>				



5" Sanding Discs with 8 Dust Holes

Disques de ponçage 125 mm avec 8 trous d'aspiration



Repl. sheets Feuilles de rempl.	5" - DH8 (125 mm)		Replacement Sheet for Discs Feuille de remplacement pour disques		Envelope Enveloppe
	Grit Grain	Part Number No produit	UPC Code Code UPC	Quantity / Masterpack* Quantité / Carton maître	Quantity / Envelope Quantité / Enveloppe



		51021	797966751021	10	1
--	--	-------	--------------	----	---

siafast

* Masterpack : number of envelopes per case
Carton Maître: nombre d'enveloppes par caisse

1960	5" - DH8 (125 mm)		Discs (aluminum oxide, yellow) Disques (oxyde d'aluminium, jaune)		Envelope Enveloppe
4 / Pack 4 / Paquet	Grit Grain	Part Number No produit	UPC Code Code UPC	Quantity / Masterpack* Quantité / Carton maître	Quantity / Envelope Quantité / Enveloppe



	040	42715	797966742715	10	4
	060	42722	797966742722	10	4
	080	42265	797966742265	10	4
	100	57719	797966757719	10	4
	120	42302	797966742302	10	4
siafast	150	57726	797966757726	10	4
	180	42326	797966742326	10	4
	220	42333	797966742333	10	4
	400	42296	797966742296	10	4

siafast

* Masterpack : number of envelopes per case
Carton Maître: nombre d'enveloppes par caisse

1960	5" - DH8 (125 mm)		Discs (aluminum oxide, yellow) Disques (oxyde d'aluminium, jaune)		Contractor Pack Entrepreneur
25 / Pack 25 / Paquet	Grit Grain	Part Number No produit	UPC Code Code UPC	Quantity / Masterpack* Quantité / Carton maître	Quantity / Envelope Quantité / Enveloppe



	040	57269	797966757269	24	25
	060	57276	797966757276	24	25
	080	57283	797966757283	24	25
	100	57689	797966757689	24	25
	120	57290	797966757290	24	25
siafast	150	57696	797966757696	24	25
	180	57306	797966757306	24	25
	220	57313	797966757313	24	25
	400	57320	797966757320	24	25

siafast

* Masterpack : number of envelopes per case
Carton Maître: nombre d'enveloppes par caisse



Multi-holes 5" & 6" Sanding Discs (for Festool)

Disques de ponçage de 125 & 150 mm (pour Festool)



Advantages:

- Very high stock removal rates and excellent finish
- Performance-enhancing grit mix with ceramic corundum
- Minimal clogging thanks to open coating
- Extremely long lifetime
- Lower abrasive consumption

Structure:

- Mixed grit types, semi-friable aluminium oxide, aluminium oxide, electrostatic coating
- Paper Backing

Applications:

- Sanding off of coatings and impurities
- Sanding unregularity at the edges of repaired surfaces
- Flattening of bodyfiller and primer filler
- Fine sanding of primer filler
- Keying of old and new varnishes

Avantages:

- Haut taux d'enlèvement et durabilité très élevés
- Moins d'encrassement
- Finition régulière, constante

Structure:

- Grain mêlé, corindon semi-friable, corindon, épandage électrostatique
- Support papier

Applications:

- Ponçage de mastic, polyester, plastique renforcé de fibre de verre
- Élimination des inégalités en bordure de la zone de réparation
- Ponçage de raccords, rouille ponctuelle, chocs de pierre
- Ponçage de pièces neuves, couches de fond d'usine

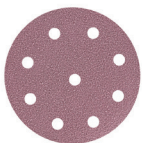
1950	5" - DH-8 + 1 (125 mm)		Discs (aluminum oxide, pink) Festool Disques (oxyde d'aluminium, rose) Festool		Contractor Pack Boîte entrepreneur
	Grit Grain	Part Number No produit	UPC Code (sleeve) Code UPC (paquet)	Quantity / Masterpack* Quantité / Carton maître	Quantity / Sleeve Quantité / Paquet
	040	58464	797966758464	-	25
	060	58471	797966758471	-	25
	080	58488	797966758488	-	25
	100	58495	797966758495	-	25
	120	58501	797966758501	-	25
	150	58518	797966758518	-	25
	180	58525	797966758525	-	25
	220	58532	797966758532	-	25
	320	58549	797966758549	-	25
	400	58556	797966758556	-	25

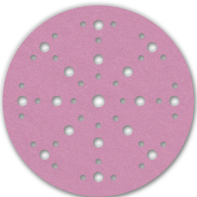
1950	6" - DH-48 + 1 (150 mm)		Discs (aluminum oxide, pink) Festool Disques (oxyde d'aluminium, rose) Festool		Contractor Pack Boîte entrepreneur
	Grit Grain	Part Number No produit	UPC Code (sleeve) Code UPC (paquet)	Quantity / Masterpack* Quantité / Carton maître	Quantity / Sleeve Quantité / Paquet
	040	58365	797966758365	-	25
	060	58372	797966758372	-	25
	080	58389	797966758389	-	25
	100	58396	797966758396	-	25
	120	58402	797966758402	-	25
	150	58419	797966758419	-	25
	180	58426	797966758426	-	25
	220	58433	797966758433	-	25
	320	58440	797966758440	-	25
	400	58457	797966758457	-	25



sianet discs for Sanding Without Dust!

Disque sianet pour un ponçage sans poussière!



Advantages:

- Full-surface dust extraction
- No dependence on hole system
- High removal rate without clogging
- High tear resistance thanks to sturdy net backing

Structure:

- 7900 sianet: Aluminum Oxide

Applications:

- Sanding of paints, plasters, varnishes primers & plastics
- Fine sanding solid wood, veneers, solid surface materials, primer plaster and plasterboard
- Preparation for polishing on high-gloss surfaces

Avantages:

- Aspiration optimale sans poussière
- Rendement de ponçage élevé sans encrassement
- Utilisable sur tout type de plateau perforé
- Grande résistance au déchirement grâce au support toile réticulé

Structure:

- 7900 sianet: Oxyde d'aluminium

Applications:

- Ponçage de peintures, vernis, mastics, d'apprêts et plastiques
- Ponçage fin de bois massif, contreplaqué, matières minérales, couche d'apprêt, placoplâtre et en fibre de plâtre
- Préparation au fini miroir



7900	5" (125 mm)		Aluminum Oxide (screen) Corindon (treillis)		
	Grit Grain	Part Number No produit	UPC Code (sleeve) Code UPC (paquet)	Quantity / case Quantité / caisse	Quantity / sleeve Quantité / paquet
	080	88768	7611123288768	300	50
	100	88782	7611123288782	300	50
	120	88805	7611123288805	300	50
	150	88829	7611123288829	300	50
	180	88843	7611123288843	300	50
	220	88867	7611123288867	300	50
	240	88881	7611123288881	300	50
	320	88904	7611123288904	300	50
	400	88928	7611123288928	300	50

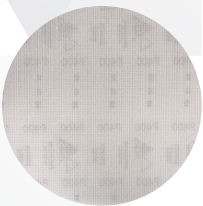

sianet discs- for Sanding Without Dust! Disque sianet pour un ponçage sans poussière!

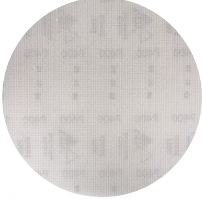

7900	6" (150 mm)		Aluminum Oxide (screen) Corindon (treillis)		
	Grit Grain	Part Number No produit	UPC Code (sleeve) Code UPC (paquet)	Quantity / case Quantité / caisse	Quantity / sleeve Quantité / paquet
	080	88546	7611123288546	300	50
	100	88560	7611123288560	300	50
	120	88584	7611123288584	300	50
	150	88607	7611123288607	300	50
	180	88621	7611123288621	300	50
	220	88645	7611123288645	300	50
	240	88669	7611123288669	300	50
	320	88683	7611123288683	300	50
	400	88706	7611123288706	300	50

sianet Discs for Drywall Sanding (for radius 360°) Disques sianet pour les murs de placoplâtre

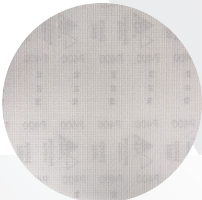

7900	8-11/16" (220 mm)		Aluminum Oxide (screen) Corindon (treillis)		
	Grit Grain	Part Number No produit	UPC Code (sleeve) Code UPC (paquet)	Quantity / case Quantité / caisse	Quantity / sleeve Quantité / paquet
	080	90921	7611123290921	100	25
	100	90945	7611123290945	100	25
	120	90969	7611123290969	100	25
	150	90983	7611123290983	100	25
	180	91003	7611123291003	100	25
	220	91027	7611123291027	100	25



Discs for Drywall Sanding (for radius 360°)

Disques pour les murs de placoplâtre (pour radius 360°)



1960		8-11/16" (220 mm)		Discs (aluminum oxide, yellow) Disques (oxyde d'aluminium, jaune)		Envelope Enveloppe
5 / Pack 5 / Paquet	Grit Grain	Part Number No produit	UPC Code Code UPC	Quantity / Masterpack* Quantité / Carton maître	Quantity / Envelope Quantité / Enveloppe	
 siafast	080	57795	797966757795	-	5	
	100	57801	797966757801	-	5	
	120	57818	797966757818	-	5	
	150	57825	797966757825	-	5	
	180	57832	797966757832	-	5	
	220	57849	797966757849	-	5	

* Masterpack : number of envelopes per case
Carton Maître: nombre d'enveloppes par caisse

1960		8-11/16" (220 mm)		Discs (aluminum oxide, yellow) Disques (oxyde d'aluminium, jaune)	
	Grit Grain	Part Number No produit	UPC Code (sleeve) Code UPC (paquet)	Quantity / Case Quantité / Caisse	Quantity / Sleeve Quantité / Paquet
 siafast	080	36267	7613387136267	500	50
	100	36304	7613387136304	500	100
	120	36335	7613387136335	500	100
	150	36366	7613387136366	500	100
	180	36373	7613387136373	500	100
	220	36410	7613387136410	500	50

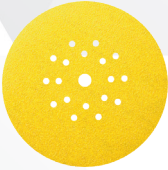
1960		9" 18 + 1 holes (225 mm) 18 + 1 trous		Discs (aluminum oxide, yellow) Disques (oxyde d'aluminium, jaune)	
	Grit Grain	Part Number No produit	UPC Code (sleeve) Code UPC (paquet)	Quantity / Case Quantité / Caisse	Quantity / Sleeve Quantité / Paquet
 siafast	080	56446	7611123256446	100	25
	100	56460	7611123256460	100	25
	120	56484	7611123259484	100	25
	150	56507	7611123256507	100	25
	180	56521	7611123256521	100	25
	220	56545	7611123256545	100	25
	240	29592	7613387629592	100	25



Self Adhesive Discs

Disques autocollants



Advantages:

- Specially designed for rotary sanding
- High productivity / Long life

Structure:

- Aluminum oxide
- Longer life
- Resin over resin / "F" paper backing

Applications:

- Ideal for sanding off rust spots, painted and colored areas

Avantages:

- Fait spécialement pour le ponçage rotatif
- Haut rendement / durabilité élevée

Structure:

- Oxyde d'aluminium
- Longue durée de vie
- Double résine / support de papier "F"

Applications:

- Idéal pour le ponçage des surfaces rouillées, peintes ou colorées

1919	6" (150 mm)		Self-adhesive Discs (aluminum oxide, red) Disque autocollants (oxyde d'aluminium, rouge)		Bulk Vrac
	Grit Grain	Part Number No produit	UPC Code (unit) Code UPC (unité)	Quantity / Case Quantité / Caisse	Quantity / Sleeve Quantité / Paquet
	040	63563	7611123063563		25
	050	63570	7611123063570		25
	060	63587	7611123063587		25
	080	63594	7611123063594		25
	100	63600	7611123063600		25
	120	63617	7611123063617		25

1919	9" (230 mm)		Self-adhesive Discs (aluminum oxide, red) Disque autocollants (oxyde d'aluminium, rouge)		Bulk Vrac
	Grit Grain	Part Number No produit	UPC Code (unit) Code UPC (unité)	Quantity / Case Quantité / Caisse	Quantity / Sleeve Quantité / Paquet
	050	63624	7611123063624		25
	080	63631	7611123063631		25
	100	63648	7611123063648		25
	120	63655	7611123063655		25

1919	12" (305 mm)		Self-adhesive Discs (aluminum oxide, red) Disque autocollants (oxyde d'aluminium, rouge)		Bulk Vrac
	Grit Grain	Part Number No produit	UPC Code (unit) Code UPC (unité)	Quantity / Case Quantité / Caisse	Quantity / Sleeve Quantité / Paquet
	050	63662	7611123063662		25
	060	63679	7611123063679		25
	080	63686	7611123063686		25
	120	63693	7611123063693		25



Resin Fiber Discs

Disques en fibre de résine



Advantages:

- Very tough and self sharpening
- Strong and tear resistant
- Excellent grit adhesion to fiber backing
- Cool cutting and aggressive grinding performance for fast sanding time

Structure:

- Aluminum oxide / full resin bond
- Heavy duty vulcanized fiber backing

Applications:

- Excellent choice for rust removal, general steels, non ferrous metals and welds grinding as well as stripping paints or stock materials on wood

Avantages:

- Très résistant et auto-affûtant
- Résistant à la déformation
- Excellent adhésion des grains au support
- Coupe froide avec ponçage agressif et performant

Structure:

- Oxyde d'aluminium / double résine
- Support de fibre vulcanisée très résistant

Applications:

- Excellent choix pour l'enlèvement de rouille et peintures, le ponçage des aciers, des métaux non ferreux et des cordons de soudure ainsi que pour enlever du matériel sur le bois

4" X 5/8" (100 X 16 mm)		Fiber Discs (aluminum oxide, red) Disques de fibre (oxyde d'aluminium, rouge)			Envelope Enveloppe
3 / Pack 3 / Paquet	Grit Grain	Part Number No produit	UPC Code Code UPC	Quantity / Masterpack* Quantité / Carton maître	Quantity / Envelope Quantité / Enveloppe
	024	44528	797966744528	10	3
	036	44535	797966744535	10	3
	080	44580	797966744580	10	3
	120	44511	797966744511	10	3

* Masterpack : number of packs per case
Carton Maître: nombre de paquets par caisse

4" X 5/8" (100 X 16 mm)		Fiber Discs (aluminum oxide, red) Disques de fibre (oxyde d'aluminium, rouge)			Bulk Vrac
	Grit Grain	Part Number No produit	UPC Code (unit) Code UPC (unité)	Quantity / Case Quantité / Caisse	Quantity / Sleeve Quantité / Paquet
	024	63709	7611123063709	150	25
	036	63716	7611123063716	200	50
	080	63730	7611123063730	200	50



Resin Fiber Discs

Disques en fibre de résine



		5" X 7/8" (125 X 22 mm)		Fiber Discs (aluminum oxide, red) Disques de fibre (oxyde d'aluminium, rouge)		Envelope Enveloppe	
3 / Pack 3 / Paquet	Grit Grain	Part Number No produit	UPC Code Code UPC	Quantity / Masterpack* Quantité / Carton maître	Quantity / Envelope Quantité / Enveloppe		
	024	45723	797966745723	10	3		
	036	45730	797966745730	10	3		
	080	45785	797966745785	10	3		
	120	45716	797966745716	10	3		

* Masterpack : number of packs per case
Carton Maitre: nombre de paquets par caisse

		5" X 7/8" (125 X 22 mm)		Fiber Discs (aluminum oxide, red) Disques de fibre (oxyde d'aluminium, rouge)		Bulk Vrac	
	Grit Grain	Part Number No produit	UPC Code (unit) Code UPC (unité)	Quantity / Case Quantité / Caisse	Quantity / Sleeve Quantité / Paquet		
	024	63822	7611123063822	150	25		
	036	63839	7611123063839	200	50		
	080	63853	7611123063853	200	50		
	100	63860	7611123063860	200	50		
	120	63877	7611123063877	200	50		

		7" X 7/8" (180 X 22 mm)		Fiber Discs (aluminum oxide, red) Disques de fibre (oxyde d'aluminium, rouge)		Envelope Enveloppe	
3 / Pack 3 / Paquet	Grit Grain	Part Number No produit	UPC Code Code UPC	Quantity / Masterpack* Quantité / Carton maître	Quantity / Envelope Quantité / Enveloppe		
	024	47727	797966747727	10	3		
	036	47734	797966747734	10	3		
	080	47789	797966747789	10	3		
	120	47710	797966747710	10	3		

* Masterpack : number of packs per case
Carton Maitre: nombre de paquets par caisse

		7" X 7/8" (180 X 22 mm)		Fiber Discs (aluminum oxide, red) Disques de fibre (oxyde d'aluminium, rouge)		Bulk Vrac	
	Grit Grain	Part Number No produit	UPC Code (unit) Code UPC (unité)	Quantity / Case Quantité / Caisse	Quantity / Sleeve Quantité / Paquet		
	016	63884	7611123063884	150	25		
	024	63891	7611123063891	150	25		
	036	63907	7611123063907	200	50		
	080	63921	7611123063921	200	50		
	100	63938	7611123063938	200	50		
	120	63945	7611123063945	200	50		



Flap discs

Disques à lamelles siaflap



Advantages:

- Very tough and self sharpening
- Excellent grit adhesion to backing plate
- Long life and cool cutting
- Lightweight and durable

Structure:

- Zirconia alumina / Aluminum Oxide
- Nylon backing
- Full resin bond

Applications:

- Excellent choice for performance grinding and high removal rate, welded seams, rust removal, and surface cleaning

Avantages:

- Très résistant et auto-affûtant
- Excellente adhésion des grains au plateau
- Longue durée de vie et coupe froide
- Léger et durable

Structure:

- Zirconium / Oxyde d'aluminium
- Plateau en plastique
- Double résine

Applications:

- Excellent choix pour un ponçage performant et un très haut taux d'enlèvement de rouille, des cordons de soudure ainsi que le nettoyage de surfaces

4-1/2" X 7/8" (115 X 22 mm)		Flap Discs (siaflap, zirconia, blue) Disques à lamelles siaflap (zirconium, bleu)			Bulk Vrac
Grit Grain	Part Number No produit	UPC Code (unit) Code UPC (unité)	Quantity / Case Quantité / Caisse	Quantity / Sleeve Quantité / Paquet	
	040	29535	7611123129535	60	10
	060	29559	7611123129559	60	10
	080	33822	7611123133822	60	10
	120	33839	7611123133839	60	10

5" X 7/8" (125 X 22 mm)		Flap Discs (siaflap, zirconia, blue) Disques à lamelles siaflap (zirconium, bleu)			Bulk Vrac
Grit Grain	Part Number No produit	UPC Code (unit) Code UPC (unité)	Quantity / Case Quantité / Caisse	Quantity / Sleeve Quantité / Paquet	
	040	31835	7611123131835	60	10
	060	31897	7611123131897	60	10
	080	31927	7611123131927	60	10
	120	31958	7611123131958	60	10

7" X 7/8" (180 X 22 mm)		Flap Discs (siaflap, zirconia, blue) Disques à lamelles siaflap (zirconium, bleu)			Bulk Vrac
Grit Grain	Part Number No produit	UPC Code (unit) Code UPC (unité)	Quantity / Case Quantité / Caisse	Quantity / Sleeve Quantité / Paquet	
	040	32016	7611123132016	60	10
	060	32078	7611123132078	60	10
	080	32108	7611123132108	60	10



GRIT USE

GUIDE D'UTILISATION DES GRAINS

GRIT / GRAIN	APPLICATION APPLICATION
PRODUCTION / PRODUCTION	
16	<ul style="list-style-type: none"> Major removal of material and levelling a surface Enlèvement important du matériel et renouvellement de la surface
24	
36	
40	
PRODUCTION / PRODUCTION	
50	<ul style="list-style-type: none"> Fast stock removal Ajustement de l'épaisseur du matériel
60	
PRODUCTION / PRODUCTION	
80	<ul style="list-style-type: none"> Medium removal of material and decreases previous sanding lines Enlèvement moyen du matériel et diminution des lignes de sablage
100	
PRODUCTION / PRODUCTION	
120	<ul style="list-style-type: none"> First stage of sanding before finishing on the raw material Première étape de sablage avant la finition sur la matière première
150	
180	
FINISH / FINITION	
220	<ul style="list-style-type: none"> First sanding step on primers Cut the surface to make it straight Cut orange peel Première étape de sablage sur les apprêts Couper la surface pour la rendre droite Couper la pelure d'orange
240	
280	
320	
FINISH / FINITION	
400	<ul style="list-style-type: none"> Sanding between layers of Primers, dyes, paints Sablage entre les couches d'apprêts, teintures, peintures
500	
FINISH / FINITION	
600	<ul style="list-style-type: none"> Use as needed to decrease sanding lines left by previous grits Utiliser au besoin pour diminuer les lignes de sablage laissées par les grains précédents
800	
FINISH / FINITION	
1000	<ul style="list-style-type: none"> Cut for preparation of polishing For glossy finishes Couper pour la préparation du polissage Pour les finis lustrés
1200	
1500	

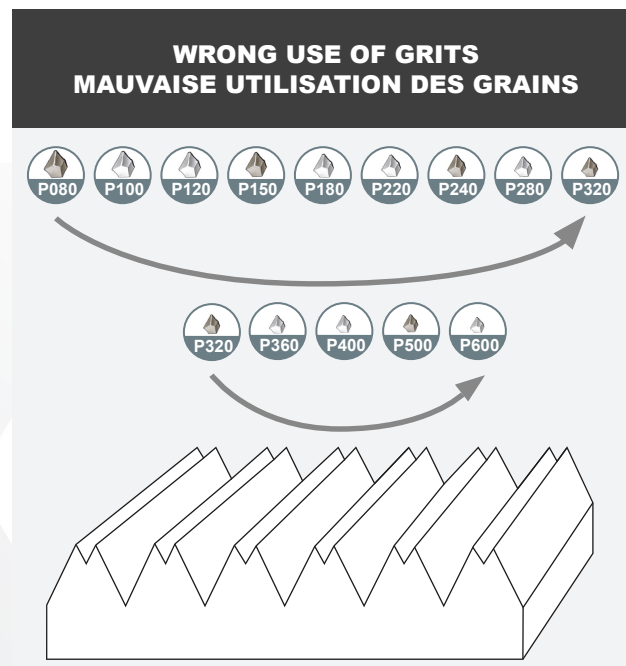
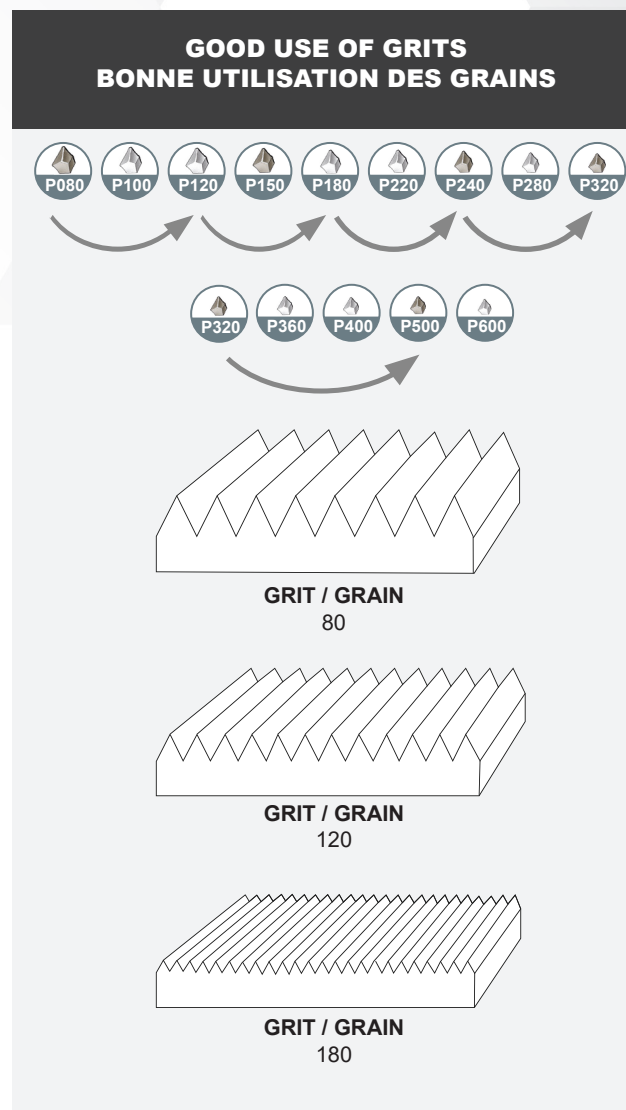



Part Number for the English Display:
0020.9556

Numéro de produit pour le présentoir en français:
0020.9557

sia-house Display / Présentoir sia-maison

	Grit Grain	Sleeve Part Number No. produit paquet	Number of sleeves Nombre de paquets	Qty / sleeve Qté / paquet
7990 siasponge combi block 2-3/4 x 4 x 1" (69 x 98 x 26 mm)				
	Medium Moyen	91329	2	10
	Fine / Fin	91008	2	10
7983 siasponge flex pads 3-3/4" X 4-3/4" X 1/2" (98 mm x 120 x 13 mm)				
	Medium Moyen	91169	2	10
	Fine / Fin	91183	2	10
6120 siavlies 6 x 9" (152 x 229 mm)				
	Very fine / Très fin	36621	1	20
7900 sianet 5" (125 mm)				
	80	88768	2	50
	120	88805	2	50
	180	88843	2	50
	240	88881	2	50
7900 sianet 6" (150 mm)				
	80	88546	2	50
	120	88584	2	50
	180	88621	2	50
	240	88669	2	50
7900 sianet 8-11/16" (225 mm)				
	80	90921	1	25
	120	90969	1	25
	240	09456	1	25
1960 siarex 9 x 11" (230 x 280 mm)				
	80	54506	1	50
	120	54544	1	50
	180	54582	1	100
	240	54629	1	100
1960 siarex 4-1/2" x 16' (115 mm x 5 m)				
	80	29981	2	1
	120	29998	2	1
	180	30017	2	1
	240	30024	2	1

Examples of Display / Exemple de présentoirs

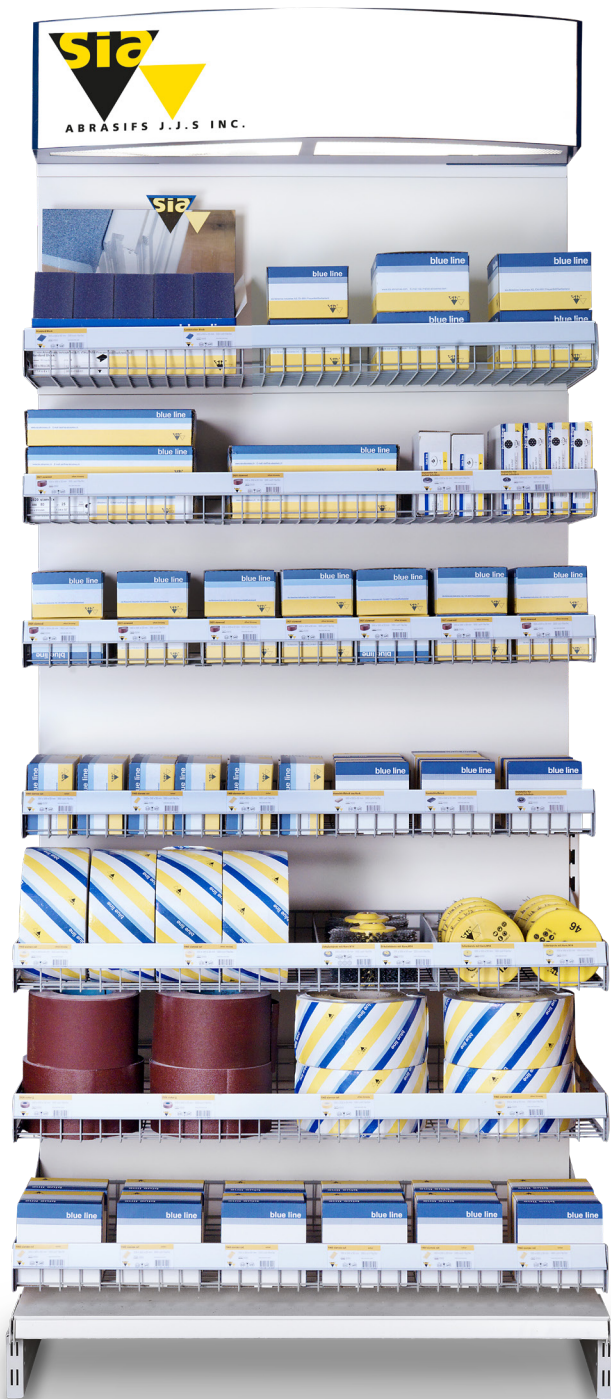

PR.7017
(Accessories not included)

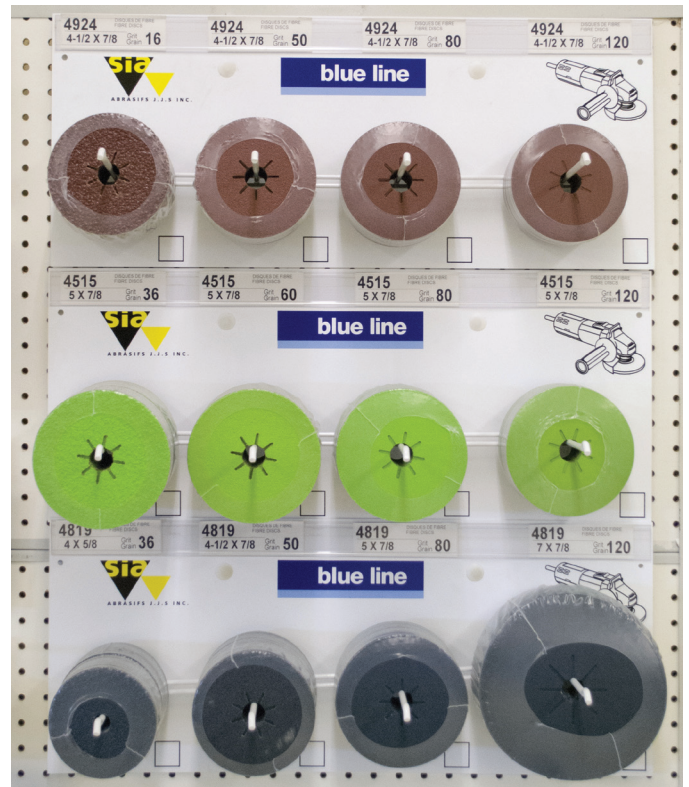

PR.DBFD.102400.0004
(Accessories not included)

ORDER FORM

BON DE COMMANDE

To / À:

Customer Service
Service à la clientèle



FAX No. / Lévis (418) 836-0537
No télécopieur Newmarket (905) 898-2405

From / De:

Company Name /
Nom de la compagnie

FAX No. /
No télécopieur

Date: ___/___/___

Expected Delivery Date
Date de livraison prévue: ___/___/___

Ship via
Expédié par _____

Order Number
Numéro de commande: _____

Quantity Quantité	Part Number Numéro de produit	Grit Grain	Description / Comments Description / Commentaires	Unit Price (\$) Prix unitaire (\$)

IF NEW CUSTOMER/
SI NOUVEAU CLIENT

ADDRESS / ADRESSE

Signature

Name / Nom



Votre source de solutions
Your Solution Partner



JJS Canada Inc.

ONTARIO/WEST CANADA

📍 1251 Gorham Street, Unit 11

Newmarket (ON) | L3Y 8Y6

📞 +1 800 337-1325

📞 +1 905 898-0116

✉️ orderdesk@jjscanada.ca

🌐 jjscanada.ca

JJS Canada Inc.

QUEBEC

📍 900 Chemin Olivier,

Levis(QC) | G7A 2N1

📞 +1 800 463-1574

📞 +1 418 836-0557

✉️ commandes@jjscanada.ca

🌐 jjscanada.ca